



Leading Conversion Technology for Power Resilience

# INVIEW

Firmware 6.x

## User Manual

### INVIEW MONITORING & CONTROL DEVICE:

- Manages your Infrastructure
- Informs the user in case of Issues
- Minimises Maintenance Expenditures
- Leverages the possibilities of IoT & Big Data
- Allows to save on your electricity bill with Energy Management



### CONTROLLERS

- INVIEW SLOT
- INVIEW S
- INVIEW X
- INVIEW XC



Copyright ©2024. Construction électroniques & telecommunications S.A.  
All rights reserved. The contents in document are subject to change without notice.  
The products presented are protected by several international patents and trademarks.  
Address: CE+T S.a, Rue du Charbonnage 12, B 4020 Wandre, Belgium  
www.cet-power.com - info@cet-power.com

VERSION 2.1



# Table of Contents

1. CE+T Power at a glance.....	6
2. Abbreviations .....	7
3. Warranty and Safety Conditions .....	8
3.1 Disclaimer .....	8
3.2 Technical care .....	8
3.3 Installation .....	9
3.3.1 Handling.....	9
3.3.2 Surge and transients .....	9
3.3.3 Other.....	9
3.4 Pre-cautions before maintenance .....	10
3.5 Replacement and Dismantling.....	10
4. Introduction .....	11
4.1 Inview Slot .....	11
4.2 Inview S .....	11
4.3 Inview X .....	12
4.4 Inview XC.....	12
4.5 Inview Widget Page .....	13
4.6 Inview Slot, S, X & XC - Specifications .....	13
4.7 Inview License .....	14
4.8 Accessories.....	15
4.8.1 MBB (Measure Box Battery).....	15
4.8.2 UMB (Universal Measure Box) .....	15
4.8.3 Accessories Specifications .....	15
5. Installation .....	17
5.1 Site preparation.....	17
5.2 Installing - Inview Slot .....	17
5.3 Mounting - Inview S .....	17
5.3.1 Panel Mounting .....	17
5.3.2 Din-rail Mounting .....	18
5.4 Mounting - Inview X .....	19
5.5 Installing - Inview XC.....	19
5.5.1 Wall mounting .....	19
5.5.2 Pole mounting .....	20
5.5.3 Panel mounting .....	20
5.6 Hardware Connections .....	20
5.6.1 Inview Slot - Connections .....	20
5.6.2 Inview S - Connections.....	21
5.6.3 Inview X - Connections.....	22
5.6.4 Inview XC - Connections.....	23
5.6.5 MBB (Measure Box Battery) - Connections .....	24

5.6.6	UMB (Universal Measure Box) - Connections .....	25
5.6.7	Output Relay Connections.....	25
5.6.8	Digital Input Connections.....	26
5.6.9	CAN / ModBus (RS485) Pin Details .....	26
5.6.10	Inview S with Bravo and Sierra - System .....	26
5.6.11	Inview X with Bravo and Sierra - System .....	27
5.6.12	Inview XC with Sierra XC - System .....	28
<b>6.</b>	<b>Overview - Web Interface .....</b>	<b>29</b>
6.1	Interface Areas .....	30
6.1.1	Header .....	30
6.1.2	Home Page.....	31
6.1.3	Widgets.....	32
6.2	Web page Controls .....	33
<b>7.</b>	<b>Power System Settings .....</b>	<b>35</b>
7.1	Login.....	35
7.2	Users Management .....	35
7.2.1	Web Interface - User account .....	36
7.2.2	LCD Interface - PIN number.....	36
7.3	Site Management .....	37
7.3.1	Site Description.....	37
7.3.2	Date and Time Settings .....	37
7.3.3	Network Settings.....	38
7.3.4	Home Page Settings .....	38
7.4	System Configuration .....	39
7.4.1	Topology Selection .....	39
7.4.2	Fallback mode.....	40
7.4.3	Phase Selection .....	41
7.4.4	AC Output Configuration .....	41
7.4.5	Converters Configuration .....	42
7.4.6	DC Configuration .....	44
7.5	Battery Configuration .....	44
7.5.1	Measurement Source .....	45
7.5.2	Battery Disconnect or LVD .....	45
7.6	Sensors and Actuators.....	46
7.6.1	MBB Configuration .....	47
7.7	Manual Bypass Configuration .....	50
7.8	Module Remote ON/OFF .....	50
7.9	Widgets Configuration .....	52
7.10	Communication Protocol.....	56
7.10.1	Modbus.....	56
7.10.2	SNMP.....	58
7.10.3	MIB .....	58
7.11	Cyber Security.....	59
7.11.1	Password Policy .....	59
7.11.2	Weak Password Alarm.....	59

7.11.3 Password Protection.....	59
7.11.4 Software Downgrade and Reset .....	59
<b>8. Overview - LCD Interface .....</b>	<b>61</b>
8.1 Inview Slot - LCD Display .....	61
8.1.1 LED Indications .....	61
8.1.2 Menu Structure .....	62
8.2 Inview S - LCD Interface.....	63
8.2.1 LED Indications .....	63
8.2.2 Menu Structure .....	64
8.3 Inview X - LCD Interface.....	65
8.3.1 Menu Structure .....	66
8.3.2 LED Indications .....	67
8.4 Inview XC - LED Indications.....	67
8.5 LCD interface - Terminology .....	67
<b>9. Defective Unit .....</b>	<b>68</b>
9.1 Return Defective Inview .....	68
<b>10. Trouble shooting and Service .....</b>	<b>69</b>
<b>11. Annexe 1: Converter - Parameter List.....</b>	<b>70</b>
<b>12. Annex 2: Boolean Expression Functionalities .....</b>	<b>71</b>
12.1 Overview.....	71
12.1.1 Our Boolean Expression Syntax .....	71
12.1.2 Examples of Basics Expressions.....	72
<b>13. Annex 3: Inview - Software Upgrade .....</b>	<b>74</b>
<b>14. Annex 4: Hardware replacement .....</b>	<b>76</b>
14.1 Inview Slot, S, X and XC.....	76
14.2 Accessories - MBB and UMB .....	77
<b>15. Annex 5: Wiring Diagrams .....</b>	<b>79</b>
15.1 Inview Slot with MBB.....	79
15.2 Inview Slot with UMB.....	80
15.3 Inview S with MBB .....	81
15.4 Inview S with UMB .....	82
15.5 Inview X with MBB .....	83
15.6 Inview X with UMB .....	84
15.7 Inview XC with MBB .....	85
<b>16. Annex 6: Auxiliary power supply kit.....</b>	<b>86</b>
16.1 Auxiliary power supply kit with Din Rail .....	86
16.2 Auxiliary power supply kit - Wiring diagram.....	86
<b>17. Annex 7: Inview Panel Sheets.....</b>	<b>87</b>
17.1 Inview S - Panel Sheets.....	87
17.2 Inview X - Panel Sheet.....	88
17.3 Inview XC - Dimensions.....	88



## Release Note:

Version	Release date (DD/MM/YYYY)	Modified page number	Modifications
1.0	23/04/2021	-	First release of the manual
1.1	27/08/2021	38	Added Remote ON/OFF details
		58 - 59	Added boolean expressions
1.2	28/09/2021	17 & 19	Updated auxiliary power supply kit part number
1.3	16/11/2022	13, 16 & 21	Added License Options, Din-rail mounting procedure and RS485 details
1.4	16/12/2022	44	Added new password policy details
1.5	14/02/2023	55 - 63	Updated section "11. Annexe 1: Converter - Parameter List"
2.0	14/09/2023	-	Updated the manual to Firmware version 6
2.1	28/02/2024	-	Added Inview XC details

# 1. CE+T Power at a glance

---

CE+T Power is your trusted partner in **advanced power solutions** engineered to meet the demands of modern and dynamic industrial applications. With over 60 years of experience in power conversion technology, CE+T Power nurtures the industry with **innovative solutions designed for critical power backup and energy management**.

Our complete range of power solutions includes **modular inverters** (DC to AC), UPS (securing AC loads with batteries), and **multi-directional converters** (inverter, rectifier, and UPS all-in-one). Coupled with our state-of-the-art **monitoring solution**, you have a real energy blender to connect multiple sources of energy seamlessly!

Whether you require **robust backup power solutions, energy management solutions, or a combination of both**, CE+T Power delivers tailored solutions to meet your specific needs. Our products are **designed with integration in mind, ensuring seamless compatibility with other components of your system**. CE+T Power is committed to providing you with the expertise and resources needed to maximize the performance of your power systems.

Thank you for choosing CE+T Power as your partner in advanced power management. Let's power the future together.

## 2. Abbreviations

---

AC	Alternating current
AL	Alarm
DC	Direct current
DHCP	Dynamic Host Configuration Protocol
DSP	Digital Signal Processor
ECI	Enhanced Conversion Innovation
EPC	Enhanced Power Conversion
ESD	Electro Static Discharge
ETH	Ethernet
HTTP	HyperText Transfer Protocol
HTTPS	Secure HyperText Transfer Protocol
LAN	Local Access Network
LVD	Low Voltage Disconnect
MBB	Measure Box Battery
MBP	Manual By-pass
MET	Main Earth Terminal
MIB	Management Information Base
N	Neutral
NTP	Network Time Protocol
NT/KO	Not Okay
NUA	Non-Urgent Alarm
PCB	Printed Circuit Board
PE	Protective Earth (also called Main Protective Conductor)
PEK	Power Extension Kit
PWR	Power
REG	Regular
SNMP	Simple Network Management Protocol
TCP/IP	Transmission Control Protocol/Internet Protocol
TRS	True Redundant Structure
UA	Urgent Alarm
UMB	Universal Measure Box
USB	Universal Serial Bus

## 3. Warranty and Safety Conditions\*

### WARNING:

Except Inview XC, the electronics in the power supply system are designed for an indoor, clean environment.

When installed in a dusty and/or corrosive environment, outdoor or indoor, it is important to:

- Install an appropriate filter on the enclosure door, or on the room's air conditioning system.
- Keep the enclosure door closed during operation.
- Replace the filters on a regular basis.

Important safety instructions, save these instructions.

### 3.1 Disclaimer

- The manufacturer declines all responsibilities if equipment is not installed, used or operated according to the instructions herein by skilled technicians according to local regulations.
- Warranty does not apply if the product is not installed, used and handled according to the instructions in the manuals.

### 3.2 Technical care

- This electric equipment can only be repaired or maintained by a “qualified employee” with adequate training. Even personnel who are in charge of simple repairs or maintenance are required to have knowledge or experience related to product maintenance.
- Please follow the procedures contained in this Manual, and note all the “DANGER”, “WARNING” AND “NOTICE” marks contained in this Manual. Warning labels must not be removed.
- Qualified employees are trained to recognize and avoid any dangers that might be present when working on or near exposed electrical parts.
- Qualified employees understand how to lock out and tag out machines so the machines will not accidentally be turned on and injure employees working on them.
- Qualified employees also understand safety related work practices, including those by OSHA and NFPA, as well as knowing what personal protective equipment should be worn.
- All operators are to be trained to perform the emergency shut-down procedure.
- Never wear metallic objects such as rings, watches, or bracelets during installation, service and maintenance of the product.
- Insulated tools must be used at all times when working with live systems.
- When handling the system/units pay attention to sharp edges.

---

\* These instructions are valid for most CE+T Products/Systems. Some points might however not be valid for the product described in this manual.

### 3.3 Installation

- This product is intended to be installed only in restricted access areas.
- The Inverter System may contain output over current protection in the form of circuit breakers. In addition to these circuit breakers, the user must observe the recommended upstream and downstream circuit breaker requirements as per the local regulations.
- Please use extreme caution when accessing circuits that may be at hazardous voltages or energy levels.
- The modular inverter rack is a dual input power supply. The complete system shall be wired in a way that both input and output leads can be made power free.
- In REG systems, to comply with local and international safety standards the N (output) and PE shall be bonded. The bonded connection between N (output) and PE must be removed once the AC input is connected.
- AC and DC circuits shall be terminated with no voltage / power applied.
- The safety standard IEC/EN62040-1-1 requires that, in the event of an output short circuit, the inverter must disconnect in 5 seconds maximum. The parameter can be adjusted on Inview controller; however, if the parameter is set at a value > 5 seconds, an external protection must be provided so that the short circuit protection operates within 5 seconds. Default setting is 60 seconds.
- The system is designed for installation within an IP20 or IP21 environment. When installed in a dusty or humid environment, appropriate measures (air filtering) must be taken.
- All illustrations in the manual are for general reference.

#### 3.3.1 Handling

- The cabinet shall not be lifted using lifting eyes.
- Remove weight from the cabinet by unplugging the inverters. Mark inverters clearly with shelf and position for correct rebuild. This is especially important in dual or three phase configurations.
- Empty module positions must not be left open. Replace with dummy cover.

#### 3.3.2 Surge and transients

The mains (AC) supply of the modular inverter system shall be fitted with Lightning surge suppression and Transient voltage surge suppression suitable for the application at hand. Manufacturer's recommendations of installation shall be adhered to. Selecting a device with an alarm relay for function failure is advised.

Indoor sites are considered to have a working lightning surge suppression device in service.

- Indoor sites Min Class II.
- Outdoor sites Min Class I + Class II or combined Class I+II. The modular inverter system/rack can reach hazardous leakage currents. Earthing must be carried out prior to energizing the system. Earthing shall be made according to local regulations.

#### 3.3.3 Other

- Isolation test (Hi-Pot) must not be performed without instructions from the manufacturer.

### 3.4 Pre-cautions before maintenance

- The modular inverter system/rack can reach hazardous leakage currents. Earthing must be carried out prior to energizing the system. Earthing shall be made according to local regulations.
- Prior to any work conducted on a system/unit make sure that AC input voltage and DC input voltage are disconnected.
- Converter modules and shelves contain capacitors for filtering and energy storage. Prior to accessing the system/modules after power down, wait at least 5 minutes to allow capacitors to discharge.
- Some components and terminals carry high voltage during operation. Contact may result in fatal injury.

### 3.5 Replacement and Dismantling

- ESD Strap must be worn when handling PCBs and open units.
- CE+T cannot be held responsible for disposal of the Inverter system and therefore the customer must segregate and dispose of the materials which are potentially harmful to the environment, in accordance with the local regulations in force in the country of installation.
- If the equipment is dismantled, to dispose of its component products, you must comply with the local regulations in force in the country of destination and in any case avoid causing any kind of pollution.

To download the latest documentation and software, please visit our website at [www.cet-power.com](http://www.cet-power.com)

## 4. Introduction

### 4.1 Inview Slot

**Inview Slot** is an advanced monitoring and controller unit for Bravo 10 and Sierra 10 power systems. This product is specially designed in 1U height to accommodate in the converter shelf and reduces the additional space in the cabinet.

The Inview Slot also allows the user to easily access the system information through inbuilt powerful LCD touch screen graphic display. In addition to the touch screen display, the user can also access the system information through the web interface and SNMP protocol.

The Inview Slot interface provides the user to access the configuration and setup files of the modules in the system. Also, it is a controller for DC regulation

Inview Slot can monitor up to 32 inverters/converters and featured with:

- 1.8" LCD touch screen display
- Three LED's to indicate Major alarm, Minor alarm and System status
- Two Digital Inputs
- Two Output Relay contacts
- Records 5000 logs as FIFO



### 4.2 Inview S

**Inview S** is an advanced monitoring and controller unit for Bravo 10, Bravo 25, Sierra 10, Sierra 25 and Flexa 25 power systems. It allows the user to easily access the system information through inbuilt powerful touch screen graphic display. In addition to the touch screen display, the user can also access the system information through the web interface and SNMP protocol.

The Inview S interface provides the user to access the configuration and setup files of the modules in the system. Like Inview Slot, it is also a controller for DC regulation.

Inview S can monitor up to 32 inverters/converters and featured with:

- 2.8" LCD touch screen display
- Three LED's to indicate Major alarm, Minor alarm and System status
- Two Digital Inputs
- Two Output Relay contacts
- Records 5000 logs as FIFO



### 4.3 Inview X

**Inview X** is an advanced monitoring and controller unit for **Bravo 10, Bravo 25, Sierra 10 and Sierra 25** power systems. It allows the user to easily view, access the system information through LCD screen graphic display and web interface. The home screen of both LCD and web interface provides a summary of system power, modules, batteries, and events information.



The Ethernet ports in Inview X allows multiple communication points for remote communication and Web interface. This additional Ethernet port makes it compulsory to use Inview X with large systems relying on the Power Extension Kit and also when Inview Gateway is required to manage several kinds of CE+T converters.

The Inview X comes up with easier access to connect accessories such as Measure Box Battery, Smart Battery BMS and so on. Its interface provides the user access to the configuration and setup files of the modules that are connected in the system. It is also a controller for DC regulation.

Inview X is featured with the following:

- Monitor up to 32 converters, and with Power Extension Kits, it can monitor up to 270.
- 7" LCD touch screen display with LED strip around the screen to indicate Major alarm, minor alarm and system status.
- Two Digital Inputs and two Output Relay contacts.
- Higher Temperature Resistance
- Records 5000 events as FIFO

### 4.4 Inview XC

**Inview XC** is an advanced monitoring and controller unit especially suited for **Sierra XC 10** power systems. It allows the user to easily access the system information through the web interface and SNMP protocol.

The Inview XC interface provides the user to access the configuration and setup files of the modules in the system. Like the other Inview interfaces, it is also a controller for DC regulation.

Inview XC is featured with the following:

- Monitors up to 32 converters.
- Three LEDs to indicate Major alarm, Minor alarm and System Status.
- Two Digital Inputs and two Output Relay contacts.
- Higher temperature resistance.





## 4.5 Inview Widget Page

The new generic view for the different InView Slot, S, and X touch screens, as well as in the web interface.

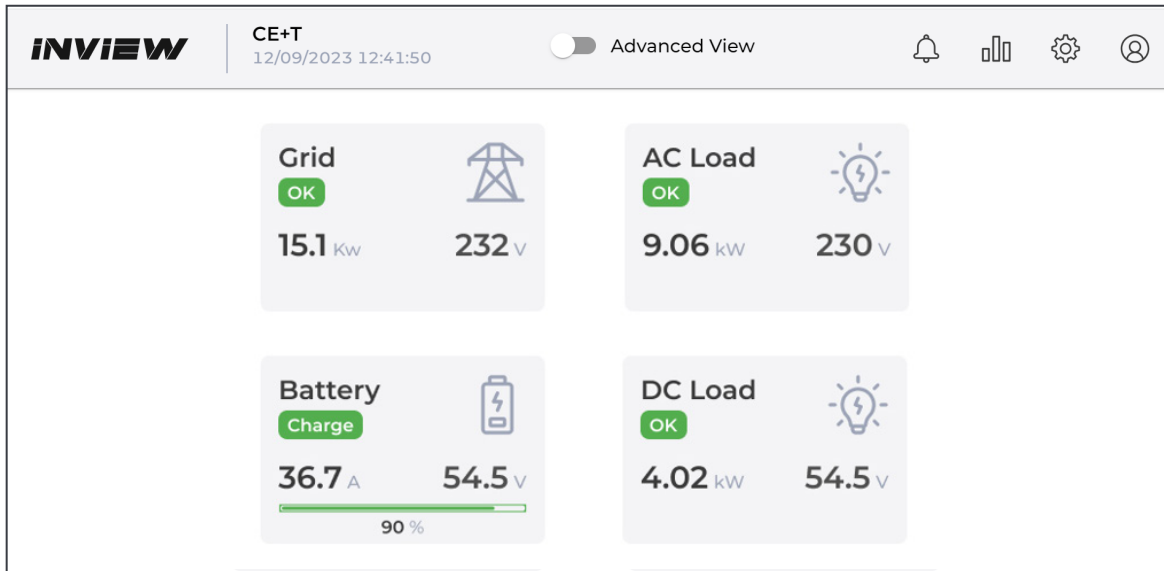

Widget view in Web interface

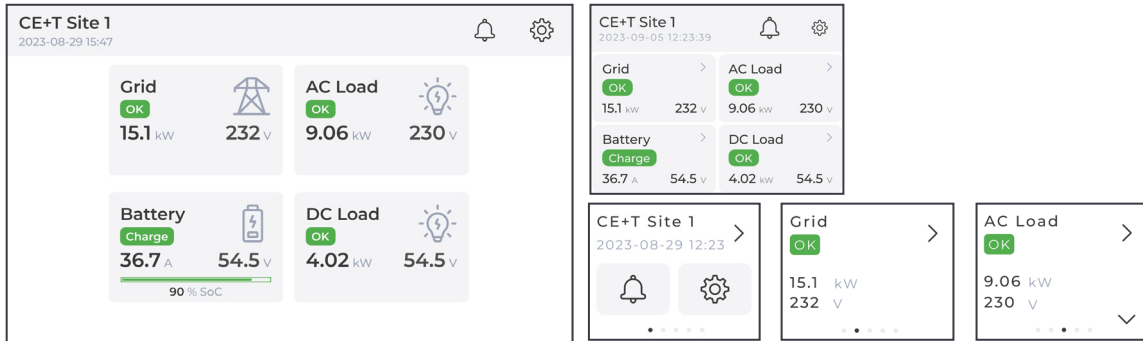

Widget view in LCD Touch screen - InView X, S and Slot (from left to right)

## 4.6 Inview Slot, S, X & XC - Specifications

Models	Inview Slot	Inview S	Inview X	Inview XC
Modules compatibility	Bravo 10 and Sierra 10	Bravo 25 and Sierra 25		Sierra XC 10 & 16
Display	1.8" resistive touchscreen	2.8" capacitive touchscreen	7" capacitive touchscreen	No (IP65 protected)
Hardware interfaces	1 x ETH, 1 x RS485, 1 x USB	1 x ETH, 1 x RS485, 1 x CAN, 1 x USB	3 x ETH, 1 x RS485, 1 x CAN, 2 x USB	1 x ETH, 1 x RS485, 1 x CAN, 1 x 19 Pin connector
Supported protocols	Modbus RS485, Modbus TCP, SNMP v1, v2C and v3, HTTP/HTTPS			
Digital input / Output relay	2 / 2			

Models	Inview Slot	Inview S	Inview X	Inview XC
Accessories	Measure Box Battery (MBB) & Universal Measure Box (UMB)			Measure Box Battery (MBB) with external power supply
Buzzer	Yes			No
Mounting	1U Shelf	DIN / Panel / Door	Panel / Door	Pole / Wall / Panel / Door
Power supply	Internal shelf 48 Vdc (40 to 60 Vdc) or External 12 Vdc (10 to 14 Vdc)	External 12 Vdc (10 to 14 Vdc)	External redundant 2 x 48 Vdc (40 to 60 Vdc)	Internal power supply 12Vdc (from Modules)
Power consumption	6 W	5 W	17 W	5 W
Operating Temperature Range	-20 to 50°C	-20 to 50°C	-40 to 65°C	-40 to 65°C
Dimension (WxHxD)	87 x 42 x 331mm	180 x 83 x 31 mm	185 x 128 x 54 mm	312 x 155 x 71 mm
Weight	650 g	240 g	725 g	2.5 kg
Part number	T602004110	T602004100	T602004200	T602004140

## 4.7 Inview License

Each Inview Slot/S/X/XC has a standard licence by default and it can be upgraded to any of the below licences. Contact your supplier or CE+T for the latest price.

S.No	License Type	Features
1	Standard (called 'Inview')	<ul style="list-style-type: none"> <li>• Modbus RS485 read-only (depending on your Hardware setup)</li> <li>• Modbus TCP read-only</li> <li>• SNMP V1, V2c, V3 read-only &amp; traps</li> <li>• Email notifications (From a certain level of alarm an email can be sent)</li> </ul>
2	Operation extension	<ul style="list-style-type: none"> <li>• Modbus and SNMP Write</li> <li>• Data records and charts (any data can be recorded)</li> <li>• Override static peak shaving (to control consumption in real-time)</li> <li>• Boolean Expression for advanced relay mapping, e.g. @es1DA502</li> <li>• HTTPS with custom certificate</li> </ul>
3	Equipment extension	<ul style="list-style-type: none"> <li>• Additional converters and 3<sup>rd</sup> part modules</li> <li>• Smart battery interfacing with battery BMS to retrieve battery</li> <li>• Accessories interfacing</li> </ul>

To know about the available license options, log in to the web interface, go to [Advanced View > Site > Data > Configuration](#), and check the ID **DA11** in the Controller section.

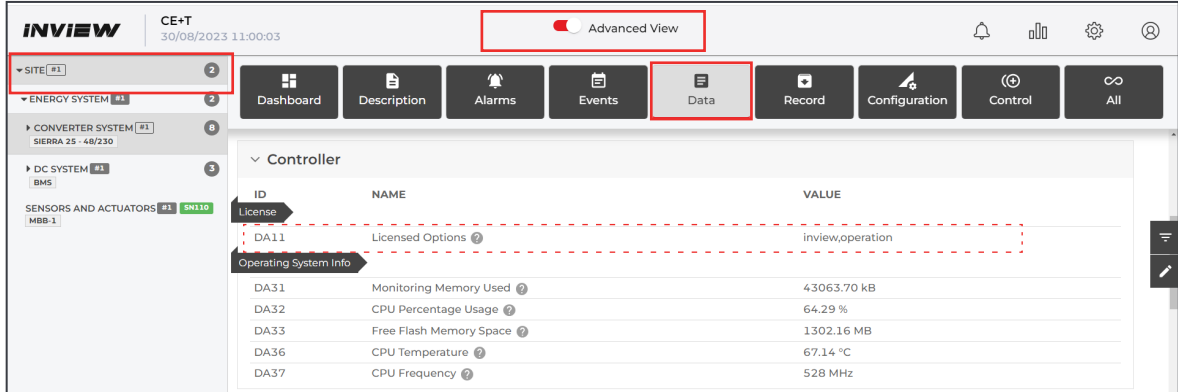

## 4.8 Accessories

### 4.8.1 MBB (Measure Box Battery)

Measure Box Battery is a unit which monitors the battery parameters such as battery voltage, current, temperature and LVD. In addition it contains extended Digital Inputs and Output Relay contacts.

It is possible to connect up to three MBB's in parallel.



### 4.8.2 UMB (Universal Measure Box)

Universal Measure Box is a unit which monitors battery parameters such as battery voltage, current, temperature, and LVD. It communicate with Inview over Modbus RS485.



### 4.8.3 Accessories Specifications

Models	Measure Box Battery	Universal Measure Box
VDC	3 Vdc inputs (maximum 60 Vdc)	2 Vdc inputs (following Vdc range)
IDC	3 ldc inputs, 0 - 60 mV shunt	1 ldc inputs, 0 - 100 mV shunt
Temperature sensor	2 (type: LM335)	1 (type: Pt 1000)
Output relays	6 (maximum 60 Vdc, 0.5 A)	3 (maximum 60 Vdc, 1 A)
Digital inputs	8 (from free potential contact)	4 (from free potential contact)
Communication	CAN	Modbus RS 485
Power supply	Through Inview or External 12 Vdc input (10 to 14 Vdc)	External 12 Vdc, 24 Vdc or 48 Vdc power supply (10 to 60 Vdc input)
Operating Temperature	-20 to 65°C	

<b>Models</b>	<b>Measure Box Battery</b>	<b>Universal Measure Box</b>
Synoptic	1 LED	2 LEDs
Mounting	DIN Rail	
Dimension (W x H x D)	160 x 97 x 38 mm	90 x 90 x 68 mm
Weight	240 g	200 g
Part number	T602006000	Measure Box 48 Vdc version: T602006048 Measure Box 90 to 430 Vdc version: T602006380

## 5. Installation

### 5.1 Site preparation

- All cables should be copper wire and must be rated for min 90°C (194°F).
- All cables must be sized according to the rated current of the Inview / Measure Box Battery and to the customer terminal connection.
- All power and signal cables should be routed properly.

### 5.2 Installing - Inview Slot

1. Place the Inview Slot and slide into the shelf.
2. Push the unit firmly until the controller rear part is engaged correctly with shelf.
3. Make sure the latch is locked in the shelf.

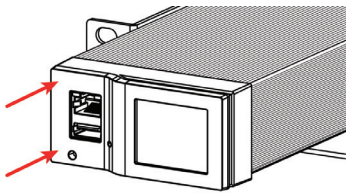

*Place the module & slide into the shelf*

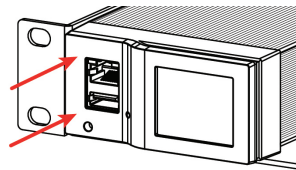

*Push firmly until module is engaged*

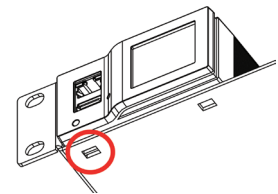

*Make sure the latch is locked in the shelf*

### 5.3 Mounting - Inview S

Before mounting the Inview S in the system, route all the required connection cables from the system and place near to the Inview S mounting location.

#### 5.3.1 Panel Mounting

1. Place the Inview S in the panel sheet.
2. Lock all the four latches at the rear side of the Inview S in the panel sheet.
3. Connect required connection cables to the Inview S.
4. Mount the panel sheet in the system with screws.

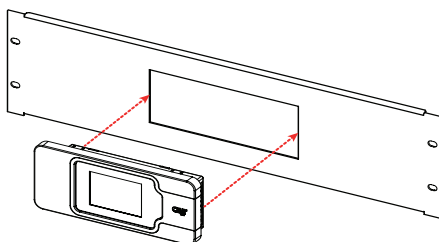

*Place the Inview S in the panel sheet*

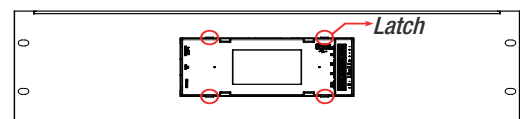

*Lock it with four latches*

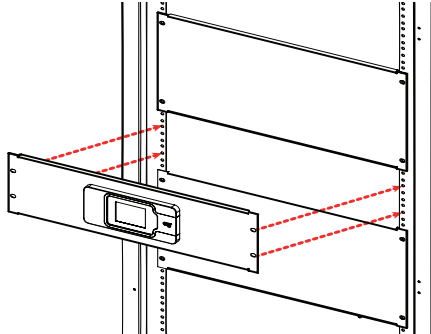

*Connect wires and place the panel sheet in the cabinet*

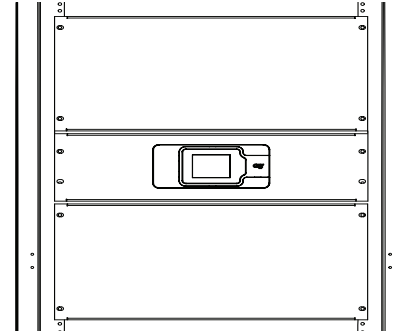

*Mount the panel sheet with screws*

*Note: To know about panel sheet dimension and cut-out details, refer “17. Annex 7: Inview Panel Sheets”, page 87.*

### 5.3.2 Din-rail Mounting

1. Place the two clips on the mounting bracket and fix them with M4x8 mm screws and washers.
2. Place the assembled mounting bracket on the Inview S rear side and fix it with self-tapping 2.9x9.5 mm screws.
3. Fix the Inview S assembly in the Din-rail.

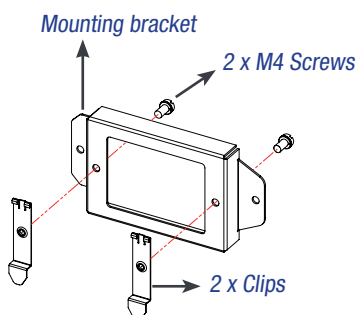

*Place clips on the mounting bracket*

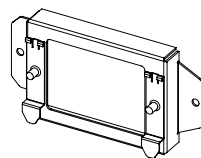

*Fix it with M4 Screws*

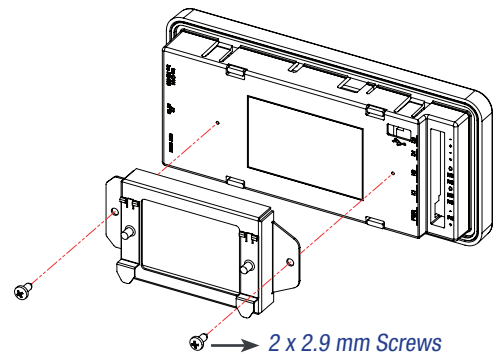

*Place the mounting bracket assembly on the Inview S*

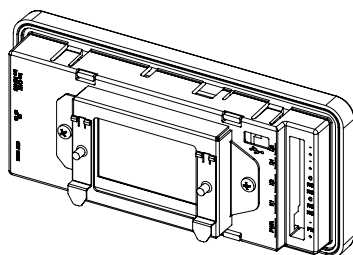

*Fix it with 2.9 mm Screws*

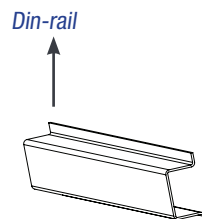

*Take the Inview assembly near to the Din-rail*

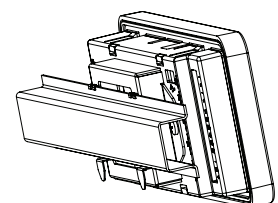
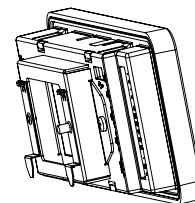

*Fix it on the Din-rail*

## 5.4 Mounting - Inview X

Before mounting the Inview X in the system, route all the required connection cables from the system and place near to the Inview X mounting location.

1. Place the Inview X in the panel sheet.
2. Fix the Inview X in the panel sheet using four screws at the rear side.
3. Connect required connection cables to the Inview X.
4. Place the panel sheet in the system and fix it with screws.

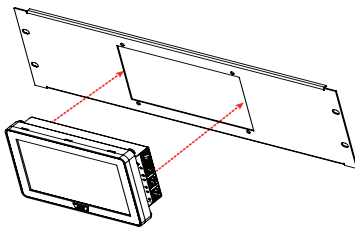

*Place the Inview X in the panel sheet*

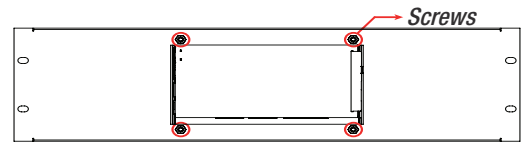

*Fix it with four screws*

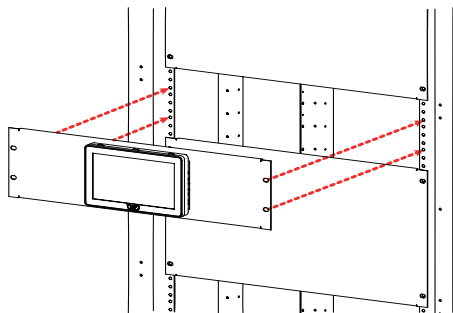

*Connect wires and place the panel sheet in the cabinet*

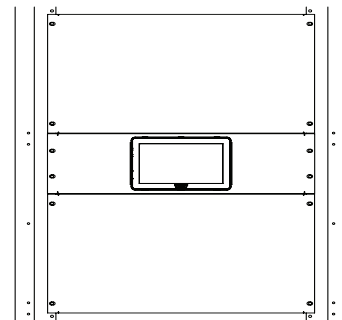

*Fix the panel sheet with screws*

**Note:** To know about panel sheet dimension and cut-out details, refer [“17.2 Inview X - Panel Sheet”, page 88](#)

## 5.5 Installing - Inview XC

Before mounting the Inview XC in the system, route all the required connection cables from the system and place them near the Inview XC mounting location.

**Note:** To know about Inview XC dimensions and hole details, refer [“17.3 Inview XC - Dimensions”, page 88](#).

### 5.5.1 Wall mounting

- Clean the wall surface.
- Lift up and hold the controller in position and mark the holes.
- Drill holes on the marked points.
- Fix the controller on the wall using the screws.

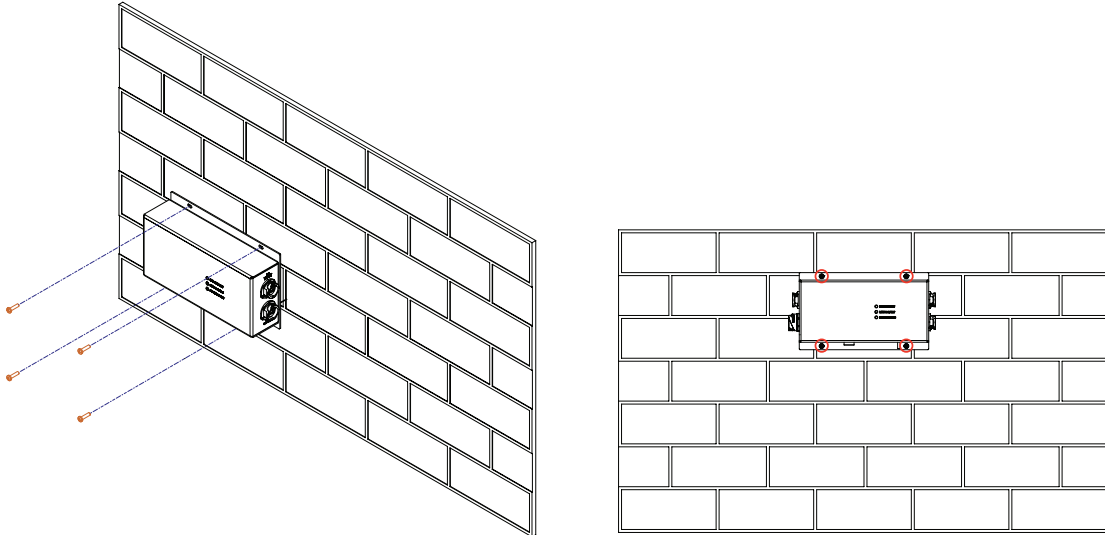

### 5.5.2 Pole mounting

Use pole mounting kits to mount the Inview XC on a pole. We suggest using the PK-121 Pole Mount Kit from Polycase (with a rail length of 305 mm) ([link](#)), or any other pole mounting kit could be used. Refer for the fixations' hole spacing.

### 5.5.3 Panel mounting

- Place the Inview XC in the panel sheet.
- Fix the Inview XC in the panel sheet using four screws at the rear side.
- Connect required connection cables to the Inview XC.
- Place the panel sheet in the system and fix it with screws.

## 5.6 Hardware Connections

This section describes the hardware connections of the Inview controllers and some measure boxes (MBB/UMB). For further information about system interconnections, refer to the converters' user manuals (Sierra, Bravo, Flexa,...) available on [www.cet-power.com](http://www.cet-power.com).

### 5.6.1 Inview Slot - Connections

Inview Slot has an ETH port and USB at the front. Output relays, digital inputs, CAN and power connections are present at the rear side of the Inview Slot connected shelf.

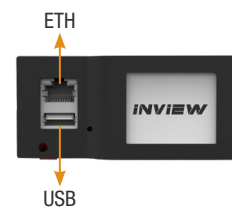



### 5.6.1.1 Inview Slot - Front connections

- **LAN port** is used for network connectivity and user can access the system information in the Web Interface. The default static IP address is 10.250.250.1/24 (the "/24" indicates the Subnet mask address: 255.255.255.0)
- **USB port** is used for internal factory purpose.

### 5.6.1.2 Inview Slot - Shelf rear connections

- **Digital Inputs (D1 and D2):** Two digital inputs are available for customer connections.
- **Output Relays (K1 and K2):** Two output relays are available and can be used for Major and Minor Alarms.
- **CAN / Modbus (RS485) port** is used to establish communication between Inview Slot and accessories. It also provide the +12 Vdc power to one Measure Box Battery. To know about RS485 pin details, refer to the section 5.6.9, page 26.
- **Power:** The redundant external auxiliary +12 Vdc and the power consumption is 5W. By default, Inview Slot takes power from DC bus. If DC is not present, it takes +12 V from external Auxiliary power supply converter (AC to DC).

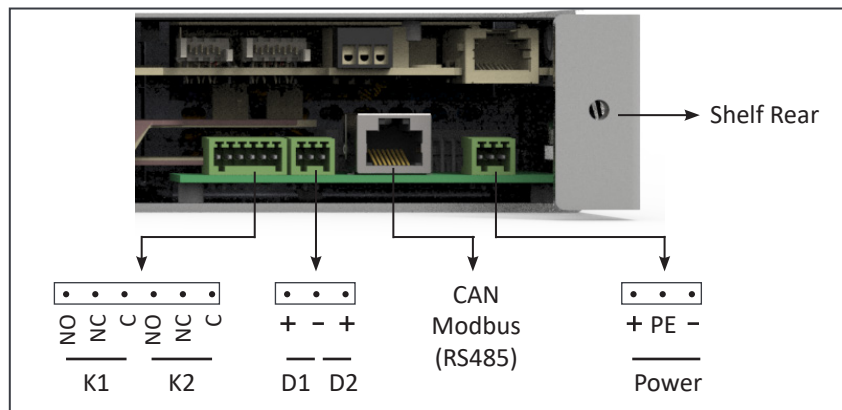

### 5.6.2 Inview S - Connections

Inview S is composed of multiple network ports, digital inputs and Output Relay contacts which are present at the rear side of the product.

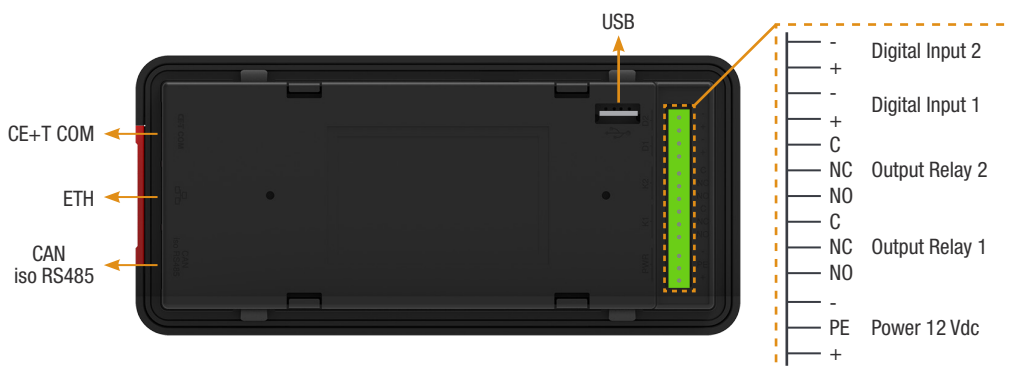

- **CE+T COM** port is dedicated to establish connection between Inview S and converters.
- **ETH ( )** port is used for network connectivity and user can access the system information in the Web Interface and SNMP. The default static IP address is 10.250.250.1/24 (the "/24" indicates the Subnet mask address: 255.255.255.0)
- **CAN / iso RS485** port is used to establish communication between Inview S and Measure Box Battery. To know about RS485 pin details, refer to the section 5.6.9, page 26. It also provides the +12 Vdc power to one Measure Box Battery.
- **USB** port is used for internal factory purpose.
- **Digital Inputs (D1 and D2)**: Two digital inputs are available for customer connections.
- **Output Relays (K1 and K2)**: Two output relays are available and it is used for Major and Minor Alarms.
- **Power**: The regulated separate +12 Vdc is required for powering the controller and the power consumption is 5W. (CE+T can provide auxiliary power supply converter (48 to 12 Vdc). Part number is **T602004120**)

### 5.6.3 Inview X - Connections

Inview X composed of multiple network ports and inbuilt free potential contacts.

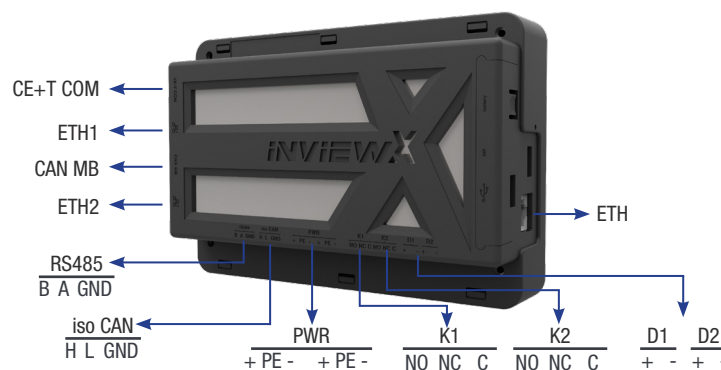

- **CE+T COM** port is dedicated to establish connection between Inview X and converters.
- **ETH** ports are used for network connectivity, and user can access the system information through the web interface.
  - **ETH Front**: DHCP server, providing access to the configuration at URL <https://inview.local> or <https://10.250.252.1>
    - Intended for direct connection of a laptop computer.  
**Warning: Do not connect this port to the network, as it might interfere with other DHCP servers.**
  - **ETH1**: Main network interface
    - Default static IP address: 10.250.250.1/24
    - It can be configured to other static addresses or as a DHCP client in a web-based configuration interface
  - **ETH2**: Secondary network interface
    - Static IP address: 10.250.251.100/24
    - It is dedicated to CE+T accessories like Inview Gateway and do not connect to the network
- **CAN MB** port is used to share the system information to the Measure Box Battery. It also provides the +12 Vdc power to three accessories which are connected in series. To know about pin details, refer to the section 5.6.9, page 26.

- **iso CAN** is used for CAN communication.
- **RS485** is used for Modbus communication.
- **USB** port is used for internal factory purpose.
- **Digital Inputs (D1 and D2):** Two potential free Digital Inputs are available for customer connections.
  - Digital Input 1 is assigned for MBP operation if used.
  - Digital Input 2 is assigned for Surge Arrester if used.
- **Output Relays (K1 and K2):** Two output relays are available and can be used for Major and Minor alarms.
- **Power:** The unregulated separate +48 V power supply is required for powering Inview X and this power should not be shared with other devices.

#### 5.6.4 Inview XC - Connections

- **CE+T COM** port is dedicated to establish connection between Inview XC and converters.
- **ETH port:** used for network connectivity and user can access the system information in the Web Interface and SNMP. The default static IP address is 10.250.250.1/24.
- **iso CAN/ RS485 ports:** for Modbus RTU and CAN communication. This port should be used for the communication with a Measure Box Battery. An external power supply is needed for the Measure Box Battery. To know about the pin details, refer to the following figure.
- An “Others” port that comprises:
  - Digital inputs (D1 and D2): Two potential free Digital Inputs are available for customer connections.
    - Digital Input 1 is assigned for MBP operation if used.
    - Digital Input 2 is assigned for Surge Arrester if used.
  - Output relays (K1 and K2): Two output relays are available and can be used for Major and Minor alarms.
  - An additional iso CAN for CAN communication.

For Inview XC, IP65 rated NLINK0 connectors must be used. Refer to the below picture for Inview XC connectors' pin details.

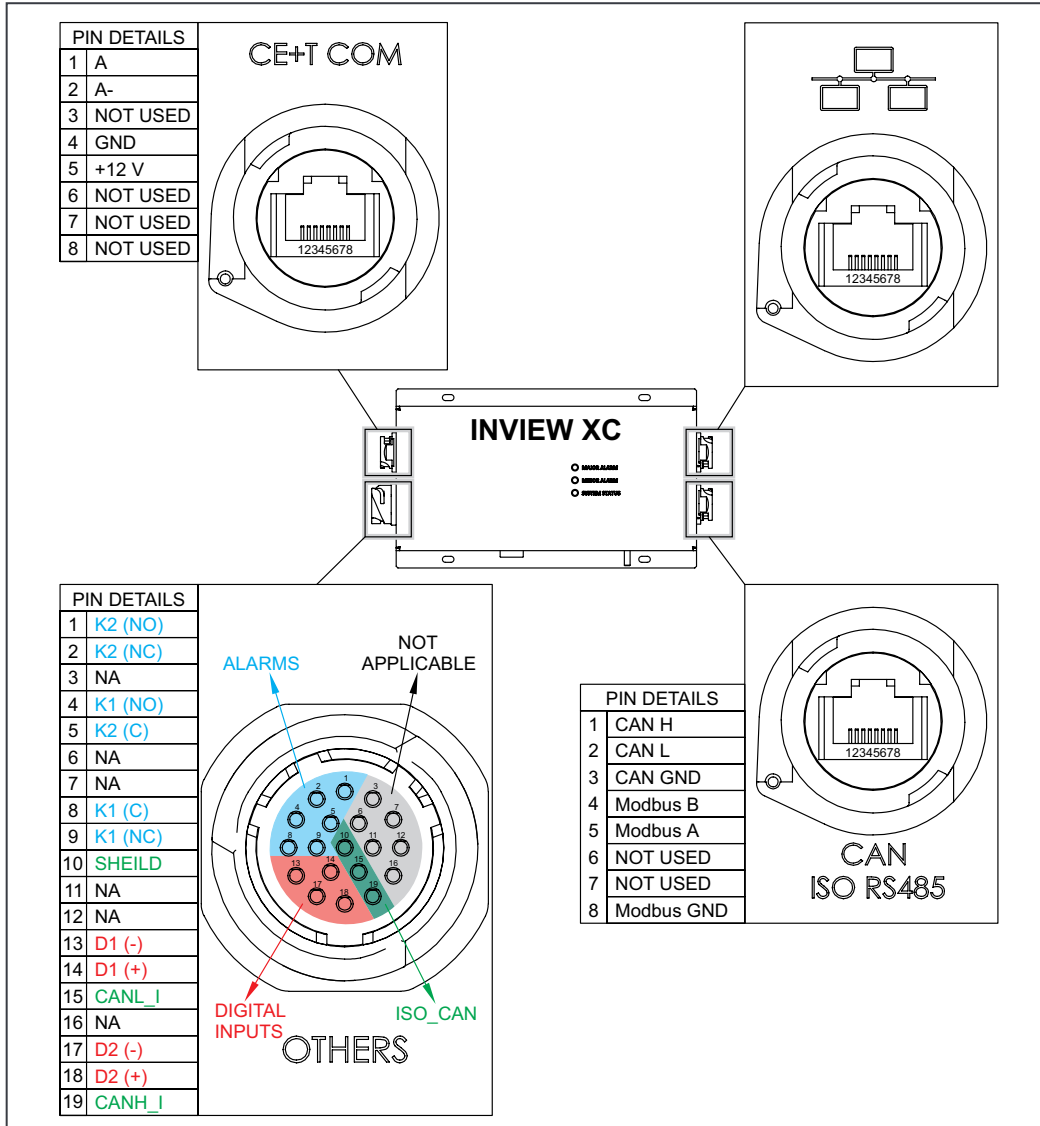

**Note:** To solder pins together on the Inview XC side of the 19 pin connector, use a magnifier to view the pin numbers. The numbering corresponds to the pin details given here above.

### 5.6.5 MBB (Measure Box Battery) - Connections

MBB is composed of multiple digital inputs and analog outputs.

- **Voltage (V1 to V3)** is used to monitor the voltage of DC. Ensure the polarity while wiring.
  - V1: common DC 48V voltage
  - V2: string 1 monitoring
  - V3: string 2 monitoring

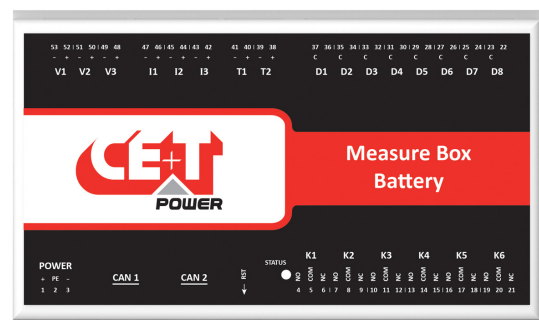



### 5.6.8 Digital Input Connections

In digital input terminal, the external voltage should not be applied and it is mandatory to connect only like switches. Each digital input terminal in Inview Slot/S/X/XC, and MBB should be connected as per diagram.

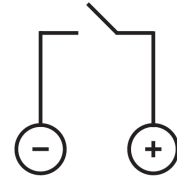

Digital input terminal

### 5.6.9 CAN / ModBus (RS485) Pin Details

Pin Number	Name	Description
1	CAN_H	CANH pin for CAN protocol
2	CAN_L	CANL pin for CAN protocol
3	GND_Can	Ground pin for CAN protocol
4	ModBus_B	ModBus B through serial port
5	ModBus_A	ModBus A through serial port
6	GND	Ground pin for MBB power supply
7	+12 VDC	+12 VDC for MBB power supply
8	GND_ModBus	ModBus ground

RJ45 Pinout T-568B

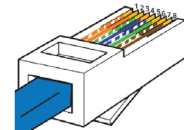
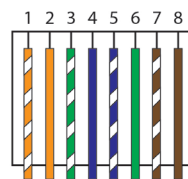

- 1. White Orange    2. Orange    3. White Green    4. Blue
- 5. White Blue    6. Green    7. White Brown    8. Brown

Note: The wire colours might vary, but make sure the wire positions are exactly crimped.

### 5.6.10 Inview S with Bravo and Sierra - System

In Bravo and Sierra systems, the Inview S, Measure Box Battery and Measure Box DC should be connected as per the following:

1. Connect “RJ45” port in shelf and “CE+T COM” port in Inview S using RJ45 straight cable.
2. Connect “CAN / iso RS485” port in Inview S and “CAN1” port in MBB / “RS485” port in UMB. (Note: this connection is not applicable for Bravo System)
3. Connect power to Inview S and MBB / UMB from auxiliary power supply kit.

#### System with Inview S and MBB

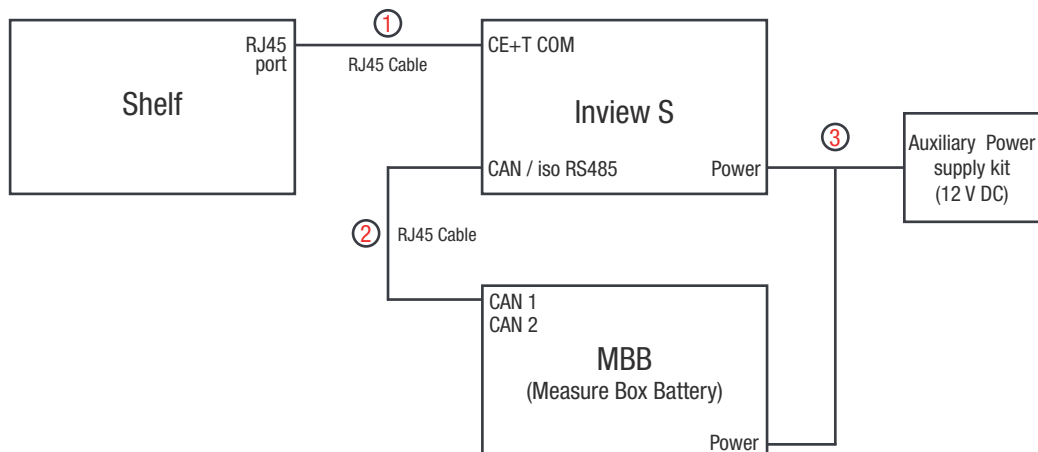

For more information about wiring refer “15.5 Inview X with MBB”, page 83.

### System with Inview S and UMB

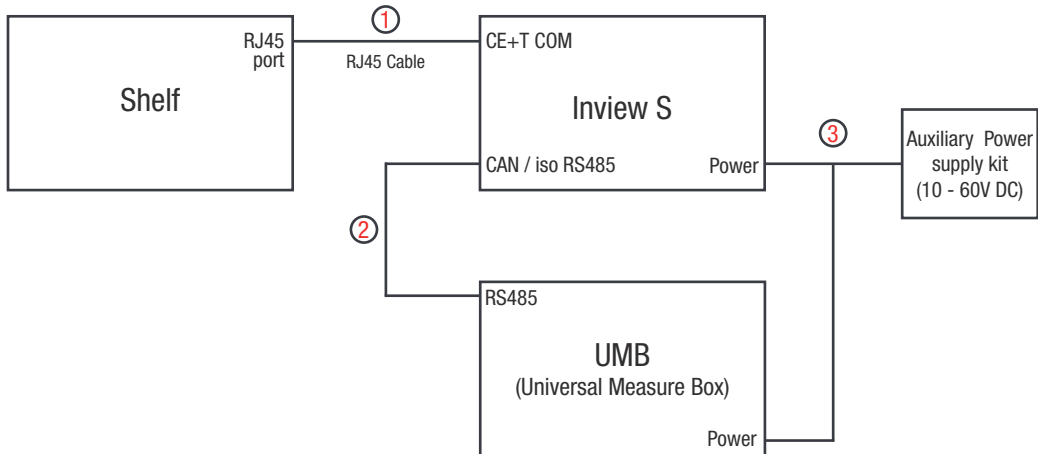

For more information about wiring refer “15.4 Inview S with UMB”, page 82.

### 5.6.11 Inview X with Bravo and Sierra - System

In Sierra system, the Inview X, Measure Box Battery and Measure Box DC should be connected as per the following:

1. Connect “RJ45” port in shelf and “CE+T COM” port in Inview X using RJ45 straight cable.
2. Connect “CAN MB” port in Inview X and “CAN1” port in MBB / “RS485” port in UMB.  
(Note: this connection is not applicable for Bravo System)
3. Connect 48 V supply to Inview X from AC to DC adapter and Battery.

### System with Inview X and MBB

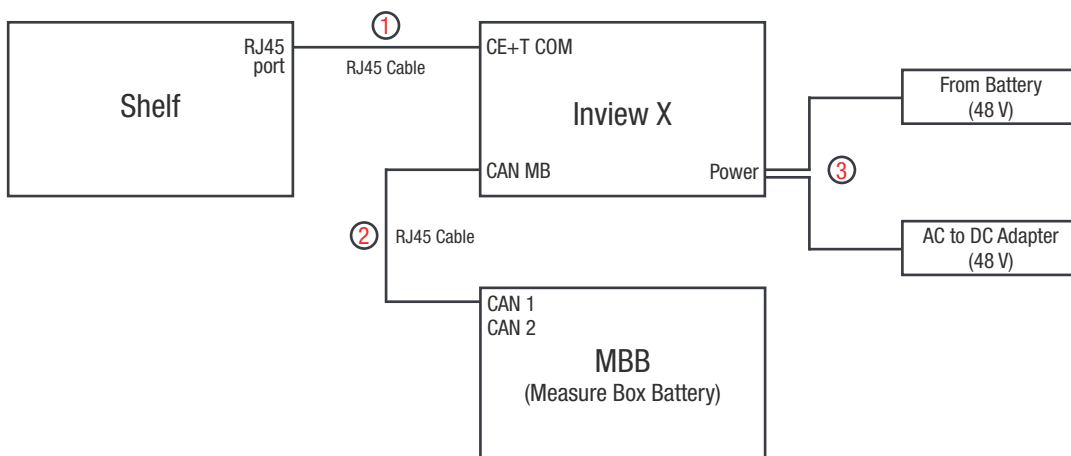

For more information about wiring refer “15.5 Inview X with MBB”, page 83.

**System with Inview X and UMB**

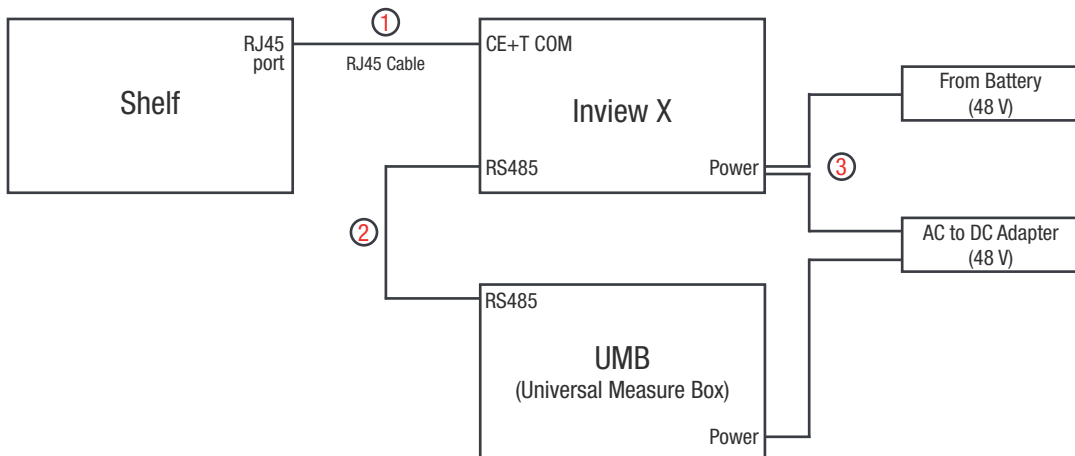

For more information about wiring refer “15.6 Inview X with UMB”, page 84.

**5.6.12 Inview XC with Sierra XC - System**

In Sierra XC module, the Inview X should be connected as per the following:

1. Connect “COM” port in Sierra XC System and “CE+T COM” port in Inview X using RJ45 straight cable.
2. Connect “CAN ISO RS485” port in Inview XC and “CAN1” port in MBB.  
(Note: this connection is not applicable for Bravo System)
3. Connect 48 V supply to Inview X from AC to DC adapter and Battery.

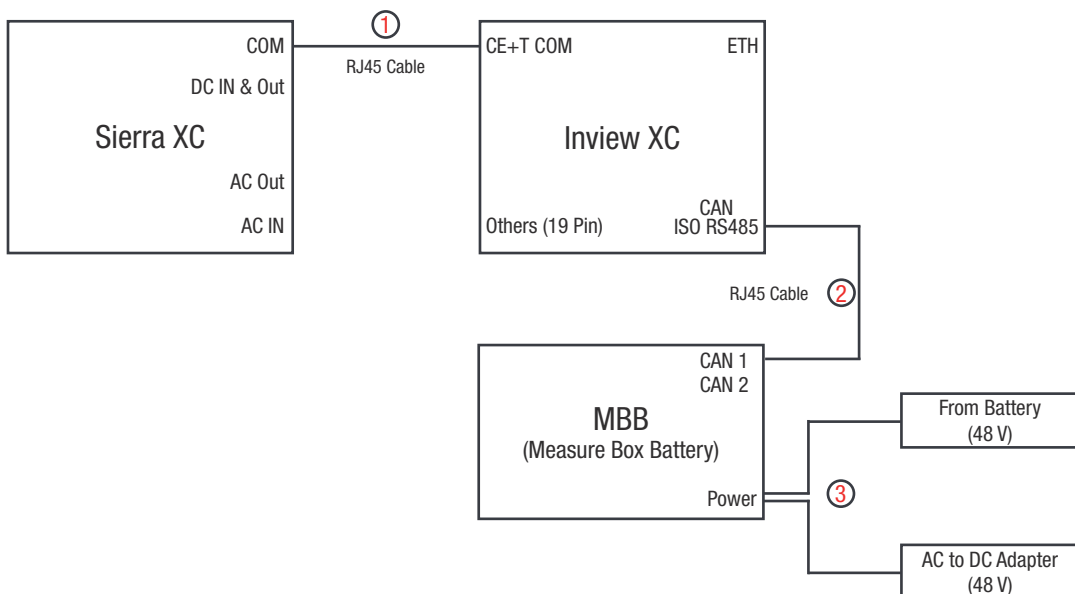

For more information about wiring refer “15.7 Inview XC with MBB”, page 85



## 6. Overview - Web Interface

The web interface of all the Inview controllers is the same. The Inview web interface allows the user to interact with system, access, configure and modify the system parameters.

The below tree provides an overview of the menu structure in the web interface.

*Note: Widgets varies depending upon the topology selection.*

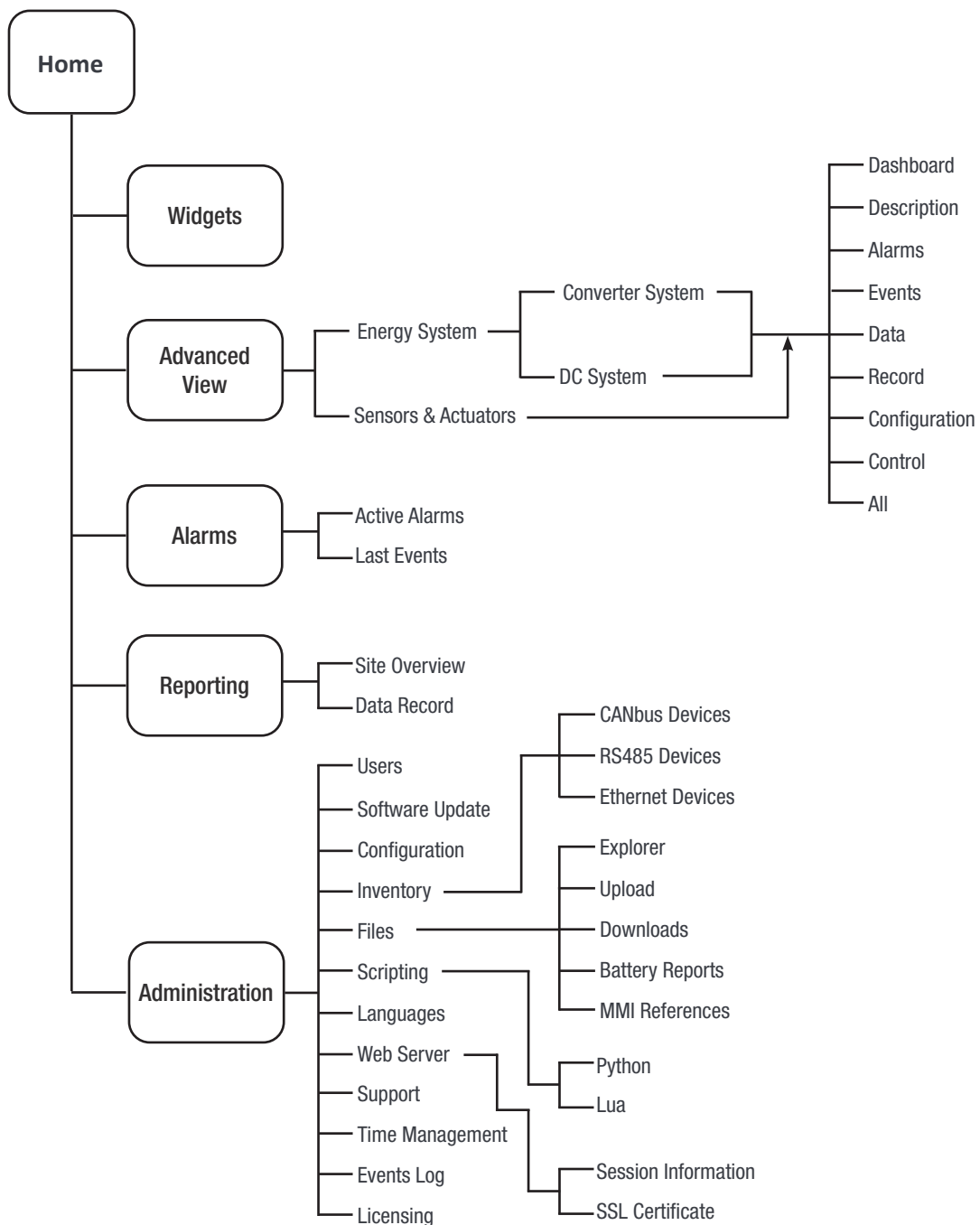

## 6.1 Interface Areas



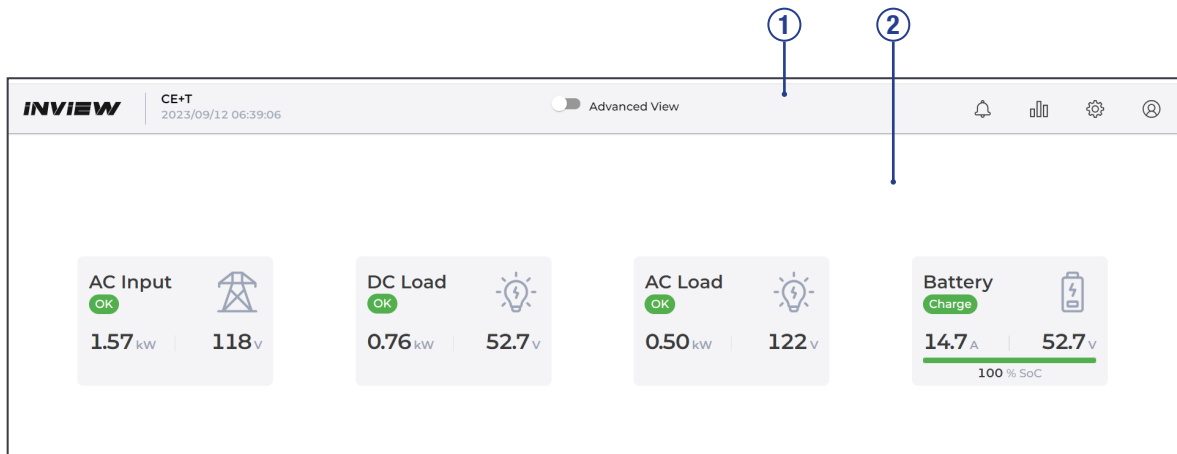

- 1 → Header
- 2 → Home Page

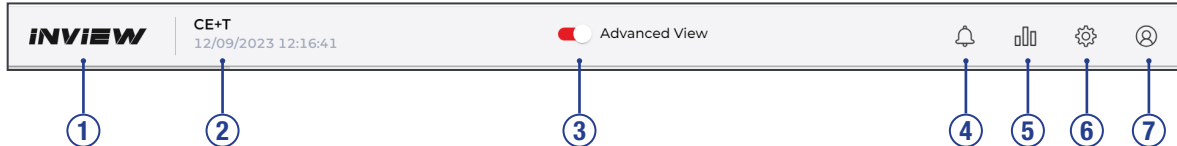

### 6.1.1 Header



The icons on the header provide quick access to the corresponding pages.

- 1 → **Home:** Clicking on **INVIEW** logo goes to the home page from any page you are accessing in the interface.
- 2 → Display the date, time and site name of the system.
- 3 → **Configuration:** Click on  to toggle between Configuration and Widget or Dashboard page.
- 4 → **Alarms:** Clicking on  goes to the Alarm page, where active alarms and last events are listed.
- 5 → **Reporting:** Clicking on  goes to Reporting page, where Data records and Site details are available.
- 6 → **Administration:** Clicking on  goes to the Administration page and provides access to many action pages such as User management, Software update, Configuration files, Reports, References, Languages selection, Support package, Time management, Events log and Licensing.
- 7 → **User Context:** Clicking on  provides the information of login account such as Basic, Expert or Admin, Quick Links to Save Configuration and reboot controller, Website links to download software and documents, Device and network information, Change Password and Logout.

### 6.1.2 Home Page

The default home page is Widgets to display system information briefly. On the Widgets home page, a maximum of 20 widgets can be configured. To know about configuration, refer to the section 7.9, page 52.

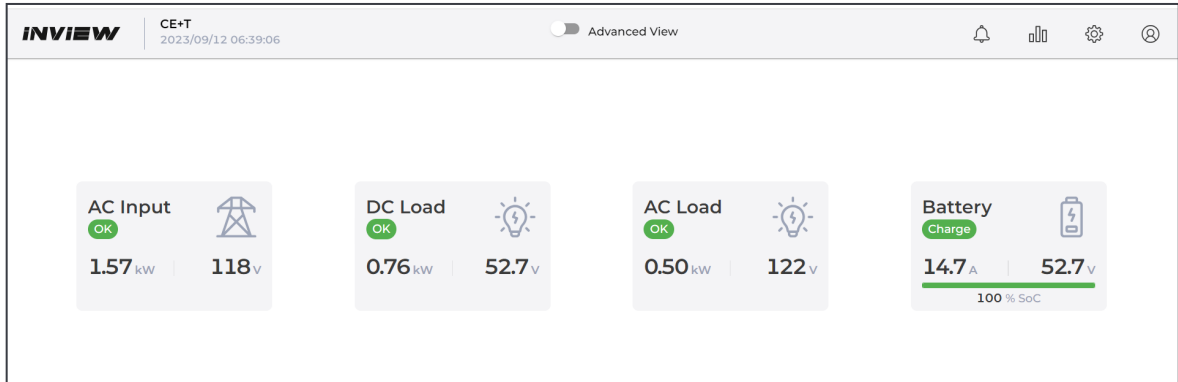

Clicking on any widget displays the corresponding details on right side of the page.

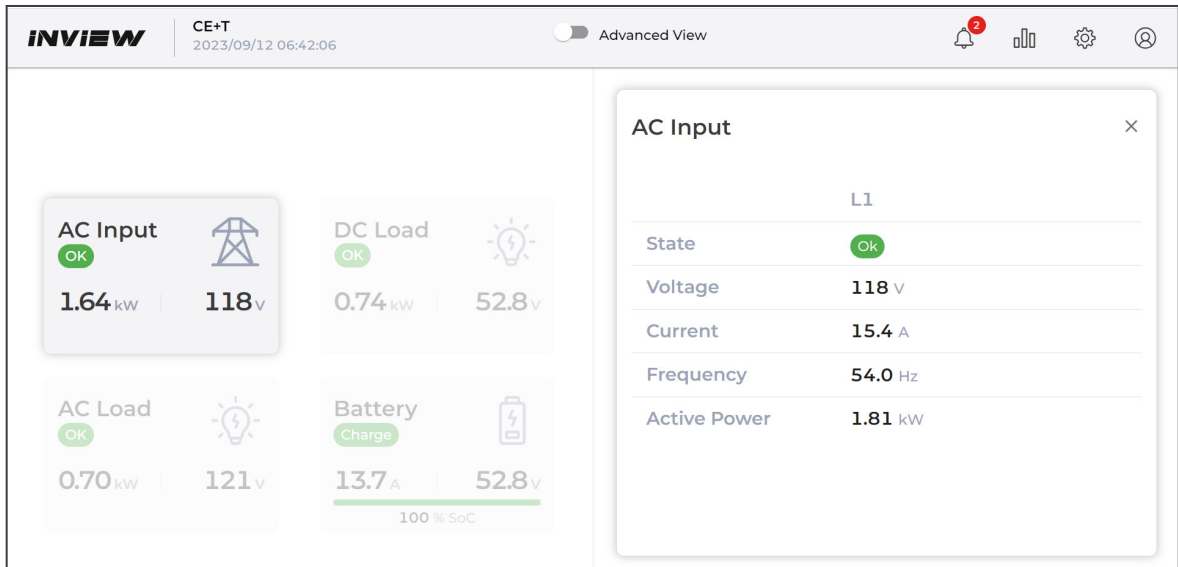

### 6.1.3 Widgets

The Inview widgets are identical for the web interface and LCD touch screens. The flexible view can be configured depending on the system topology with the following types of widgets:

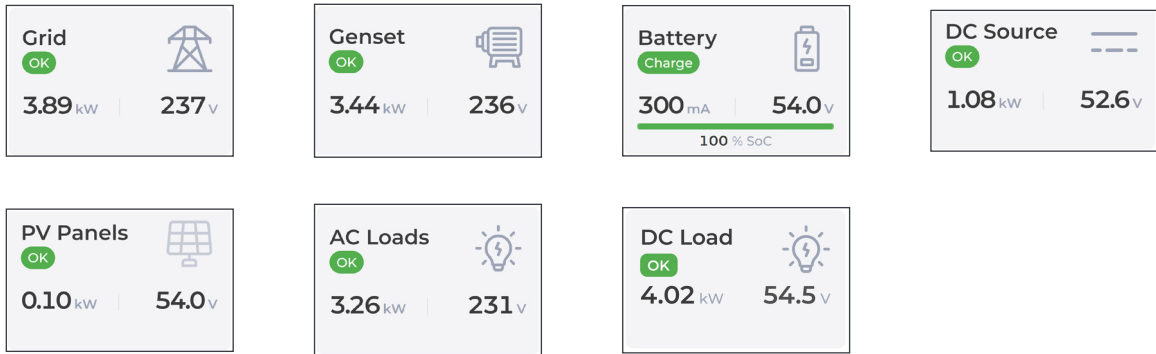











Source and Load are the different convention signs used for the different assets. The conventions of the different assets are listed in the below table. Based on the type of asset, the widget icon is displayed on the home page.

S.No	Widget	Convention Type	Power Supplied	Power Received
1	Grid	Source	Positive	Negative
2	Genset	Source	Positive	Negative
3	Battery	Load	Negative	Positive
4	DC Source	Source	Positive	Negative
5	Solar	Source	Positive	Negative
6	AC Load	Load	Negative	Positive
7	DC Load	Load	Negative	Positive



## 6.2 Web page Controls

Placing or clicking on it performs the corresponding action.

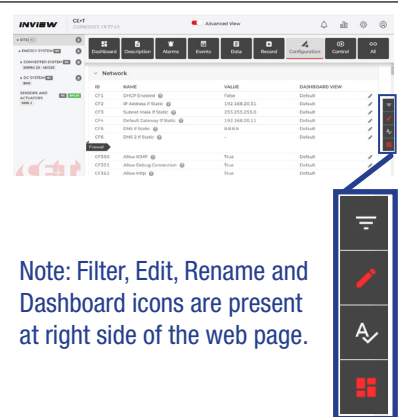
Controls	Description
	Filters: Page displays depending upon the filter selection.
	Page changes to edit mode and the user can change the parameters. If any parameter value is changed, the edit icon changes to modification icon and displays the list.
	Rename the parameter name.
	Select the corresponding parameter to either display or not on the Dashboard tab of the Advanced View page.
	On-Board help: Provide a short description to help to know about the corresponding parameters.
	Page or section expands
	Page or section collapse
	Particular section opens in a new tab
	Particular section open as a pop-up
	Drop down list – more options are present
	Delete / Clear the corresponding parameter.

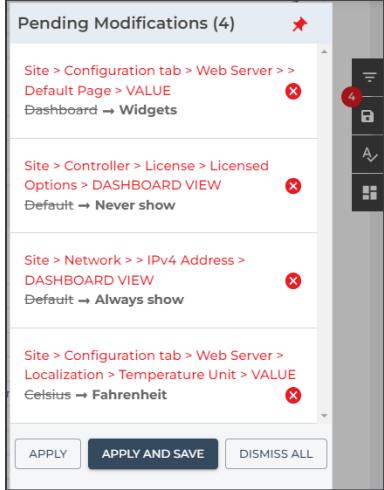

Note: Filter, Edit, Rename and Dashboard icons are present at right side of the web page.

Controls	Description
	<p><b>Modifications list:</b> It appears at right side of the “Advanced View” page. This list helps the user to overview the changes and can apply the required parameters.</p> <p><b>Apply:</b> Clicking on “<b>APPLY</b>” button, the controller accepts all the parameter changes in the modifications list.</p> <p><b>Apply and Save:</b> Clicking on “<b>APPLY AND SAVE</b>” button, the controller accepts all the parameter changes in the modifications list and saves them in the configuration file.</p> <p><b>Dismiss All:</b> Clicking on “<b>DISMISS ALL</b>” button, the controller rejects all the parameter changes in the modifications list.</p> <p>Clicking on  button, the controller rejects only the particular modification from the list.</p> <p><b>Note:</b> The number on the icon indicates the number of modifications in the list.</p> 

# 7. Power System Settings

Once system is powered on, the Inview Slot, S, X or XC is up and ready for operation. Configuration and other parameters can be changed using the web interface. Perform the following procedure to configure the system through web interface.

## 7.1 Login

Open the web browser and type the default IP address **10.250.250.1** in the address field and press enter.

**Note:** Use any one of the following latest web browsers: Google Chrome, Mozilla Firefox, Safari, or Microsoft Edge.

Inview Slot, S, X and XC have three login – Basic, Expert and Admin. All three login is password protected.

The default password for all three logins is “1234”. It can be modified, refer section 7.2.1, page 36.

An auto-logout feature is available to avoid a user being connected all the time. When no action is performed for more than **10 minutes**, the session will expire and goes to login screen.

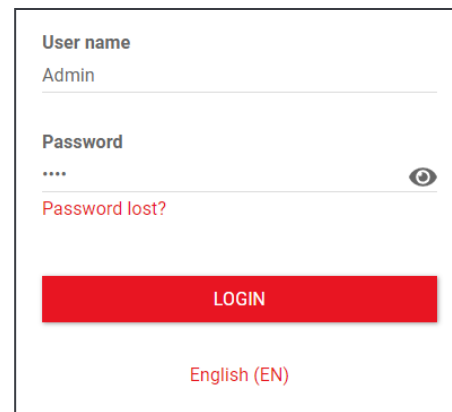

## 7.2 Users Management

Users page provides the access to create and modify the user accounts for web interface and PIN modification for LCD interface.

Go to [Administration > Users](#)

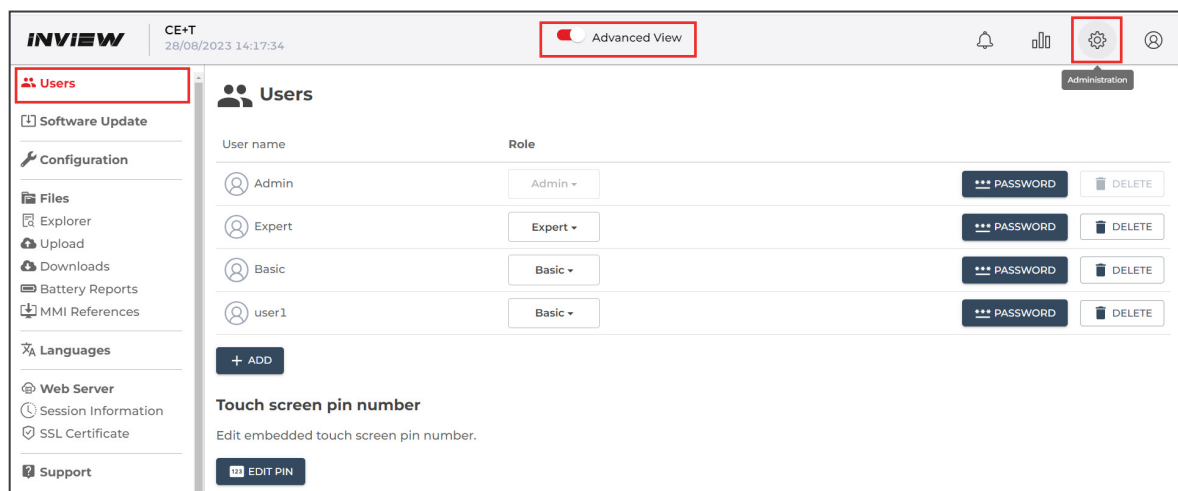

User name	Role	Actions
Admin	Admin	PASSWORD, DELETE
Expert	Expert	PASSWORD, DELETE
Basic	Basic	PASSWORD, DELETE
user1	Basic	PASSWORD, DELETE

**Touch screen pin number**  
Edit embedded touch screen pin number.  
EDIT PIN

### 7.2.1 Web Interface - User account

Users can create up to **ten** accounts for web interface and assign role as Admin, Expert, or Basic.

- **Basic** – User can only view the parameters and download the files. Advanced parameters are hidden by default and can be displayed via a tick box.
- **Expert** - User can access and modify all the applicable parameters, and can change their own password. Advanced parameters are hidden by default but can be displayed via a tick box.
- **Admin** – User can access, modify all the applicable parameters, and manage user accounts. All parameters are displayed by default (**Note: The manufacturer created Admin account cannot be deleted**)

**Note:** The feature of creating and editing user account is available only in Admin privilege.

- **Creating a new user account**

- a) In Users page, Click on “+ADD” button. A pop window appears with the title “Add a new user.”
- b) Enter an appropriate user name and assign a role from the drop down list as Basic or Expert.
- c) Enter a new password, type the same password for confirmation, and then click **ADD** button. The password length should be at least eight characters.

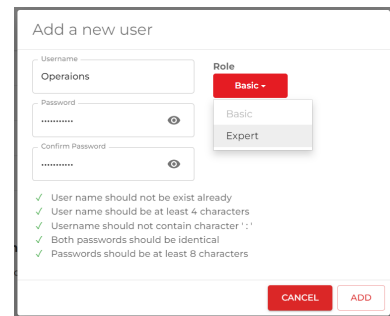

- **Editing the existing user account**

In the Users page, choose a user account which you like modify.

- Modify the privilege from the “Role” drop-down list as Expert or Basic.
- Click on “PASSWORD” button to edit existing password.
- Click on “DELETE” button to remove the user account.

### 7.2.2 LCD Interface - PIN number

Inview Slot, S, X and XC LCD interface do not have any user account; the user can view the system details and cannot modify the parameters. The LCD interface is protected with the PIN during any action request.

The default PIN is **1234**.

- **Editing the LCD PIN number**

- a) Select [Administration > Users](#).
- b) In users page, Click on “EDIT PIN” button below the “Touch screen pin number”.
- c) Enter a new pin, type the same for confirmation, and then click **OK**. The pin should be four characters.

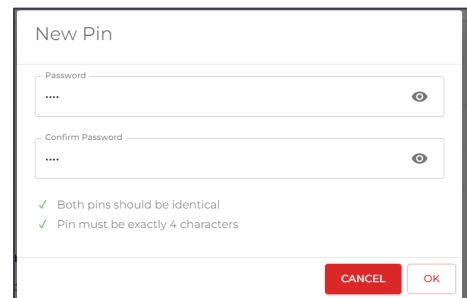



## 7.3 Site Management

### 7.3.1 Site Description

Go to [Advanced View](#) > [Site](#) > [Description](#).

Enter the Site details such as *Site description, Location and Contact details.*

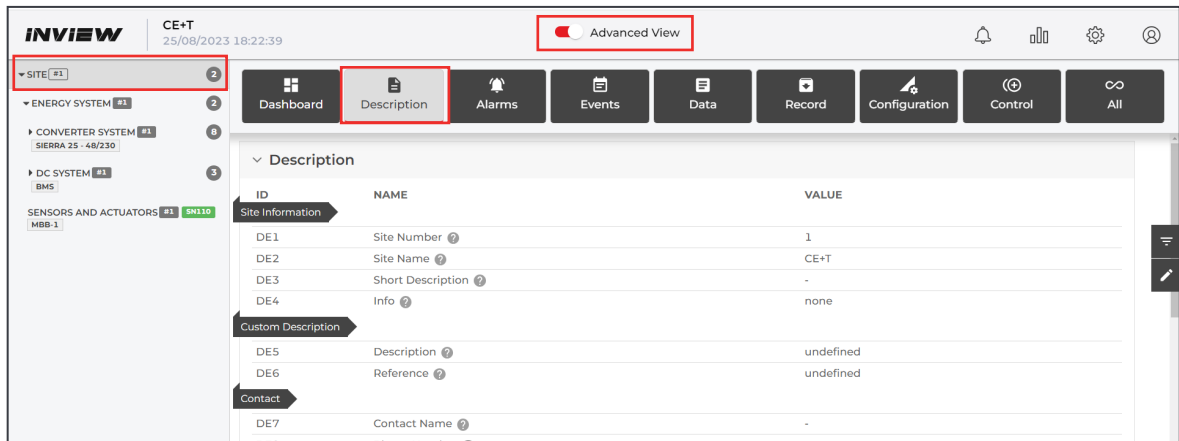

ID	NAME	VALUE
<b>Site Information</b>		
DE1	Site Number	1
DE2	Site Name	CE+T
DE3	Short Description	-
DE4	Info	none
<b>Custom Description</b>		
DE5	Description	undefined
DE6	Reference	undefined
<b>Contact</b>		
DE7	Contact Name	-

### 7.3.2 Date and Time Settings

Go to [Advanced View](#) > [Administration](#) > [Time Management](#).

Choose any one option from the below.

- **Update with local time:** Inview read the laptop time during the configuration and adapt that time.
- **Update with NTP:** Inview Internal clock synchronizes with the server time.

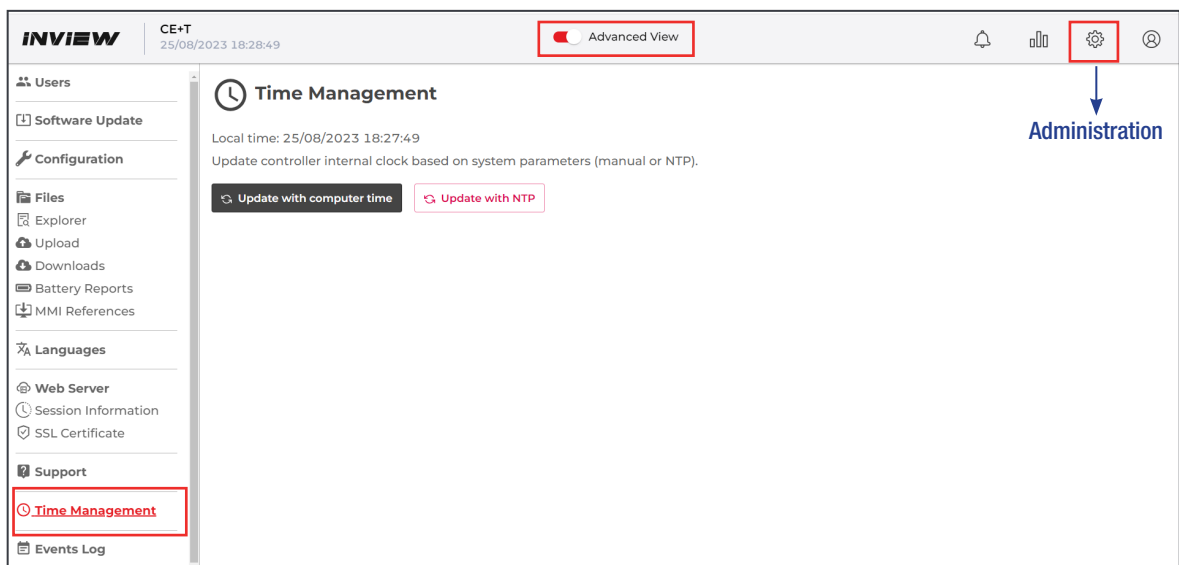

Local time: 25/08/2023 18:27:49  
Update controller internal clock based on system parameters (manual or NTP).

### 7.3.3 Network Settings

Go to [Advanced View](#) > [Site](#) > [Configuration](#)

Enter the network details such as *IP address, Firewall settings, NTP time, web server*, and applicable parameters.

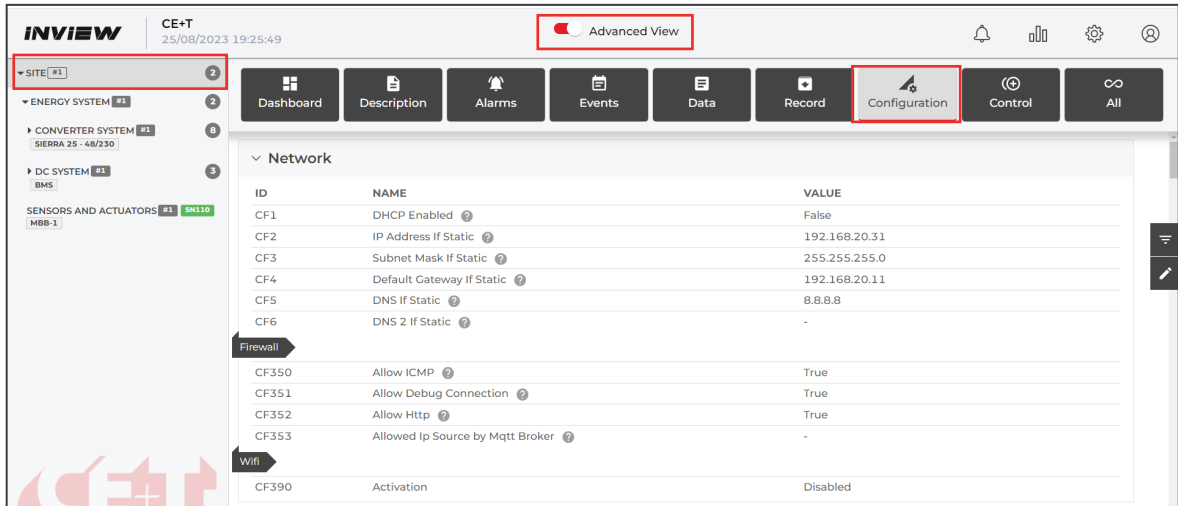

The screenshot shows the INVIEW interface with the 'Advanced View' toggle active. The left sidebar shows a tree view with 'SITE #1' selected. The main content area is titled 'Network' and contains a table of configuration items. The 'Configuration' menu item in the top navigation bar is highlighted with a red box.

ID	NAME	VALUE
CF1	DHCP Enabled	False
CF2	IP Address If Static	192.168.20.31
CF3	Subnet Mask If Static	255.255.255.0
CF4	Default Gateway If Static	192.168.20.11
CF5	DNS If Static	8.8.8.8
CF6	DNS 2 If Static	-
<b>Firewall</b>		
CF350	Allow ICMP	True
CF351	Allow Debug Connection	True
CF352	Allow Http	True
CF353	Allowed Ip Source by Mqtt Broker	-
<b>Wifi</b>		
CF390	Activation	Disabled

### 7.3.4 Home Page Settings

To set the Widgets or Dashboard as Home page, go to [Advanced View](#) > [Site](#) > [Configuration](#), scroll down to Web Server section. In ID CF31, enter “Widgets” or “Dashboard”.

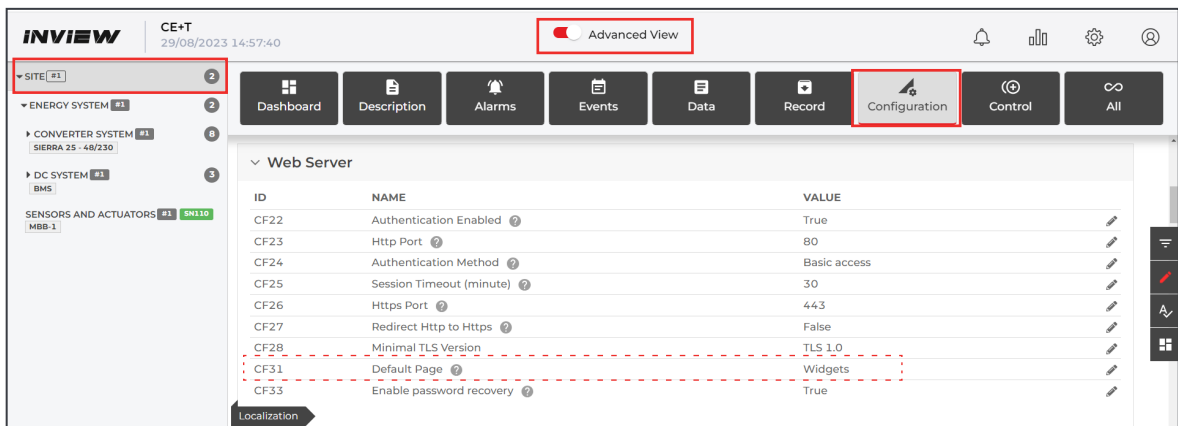

The screenshot shows the INVIEW interface with the 'Advanced View' toggle active. The left sidebar shows a tree view with 'SITE #1' selected. The main content area is titled 'Web Server' and contains a table of configuration items. The 'Configuration' menu item in the top navigation bar is highlighted with a red box. The row for ID CF31 is highlighted with a red dashed box.

ID	NAME	VALUE
CF22	Authentication Enabled	True
CF23	Http Port	80
CF24	Authentication Method	Basic access
CF25	Session Timeout (minute)	30
CF26	Https Port	443
CF27	Redirect Http to Https	False
CF28	Minimal TLS Version	TLS 1.0
CF31	Default Page	Widgets
CF33	Enable password recovery	True

## 7.4 System Configuration

To configure the converter systems, In Advanced View, go to *Site > Energy System > Converter System > Configuration*

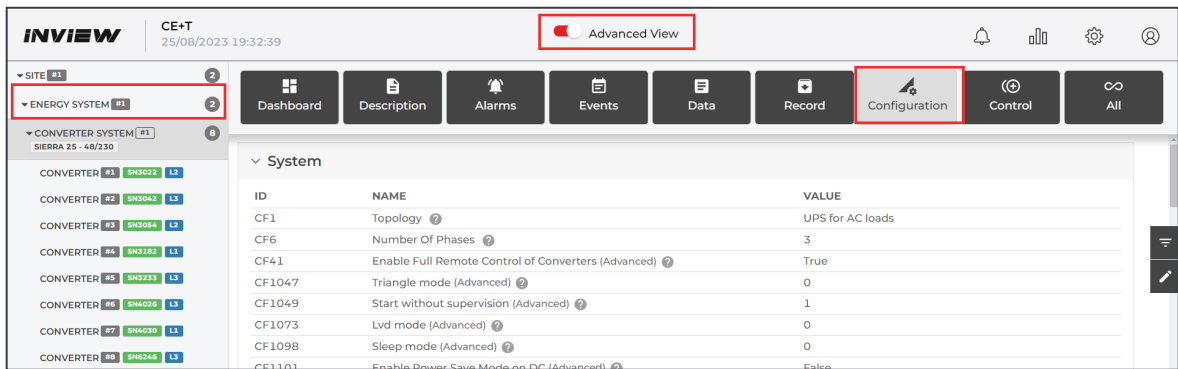

ID	NAME	VALUE
CF1	Topology	UPS for AC loads
CF6	Number Of Phases	3
CF41	Enable Full Remote Control of Converters (Advanced)	True
CF1047	Triangle mode (Advanced)	0
CF1049	Start without supervision (Advanced)	1
CF1073	Lvd mode (Advanced)	0
CF1098	Sleep mode (Advanced)	0
CF1101	Enable Power Save Mode on DC (Advanced)	False

### 7.4.1 Topology Selection

In Advanced View, go to *Site > Energy System > Converter System > Configuration > System > Global*. In System section > ID CF1, select the topology from the drop-down list based upon the system design.

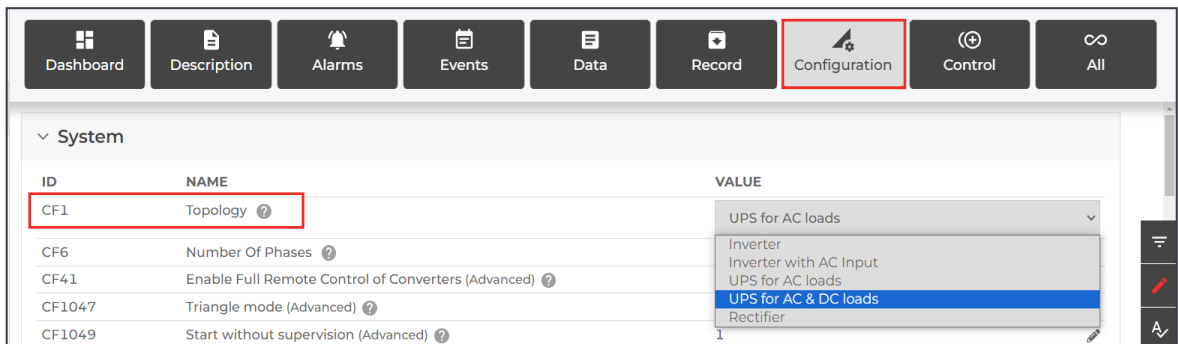

ID	NAME	VALUE
CF1	Topology	UPS for AC loads
CF6	Number Of Phases	
CF41	Enable Full Remote Control of Converters (Advanced)	
CF1047	Triangle mode (Advanced)	
CF1049	Start without supervision (Advanced)	1

After selecting the topology, scroll down to *DC > Modes* section on the same page and set the ID CF1071 to "0" or "1" as per in the following table.

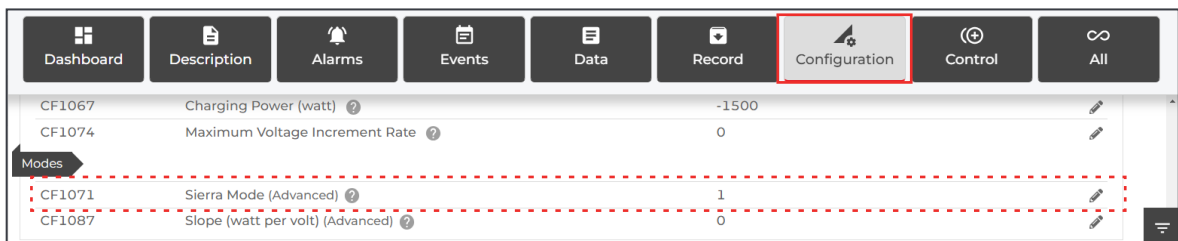

ID	NAME	VALUE
CF1067	Charging Power (watt)	-1500
CF1074	Maximum Voltage Increment Rate	0
CF1071	Sierra Mode (Advanced)	1
CF1087	Slope (watt per volt) (Advanced)	0

Topology CF1	Supported Modules	Input	Output	Parameter ID CF1071	Parameter ID CF1066	Parameter ID CF1067	Parameter ID CF1074
Inverter (REG DC / AC only)	Bravo 25, 20 and 10	DC	AC load	0	NA	NA	NA
Inverter with AC Input (EPC mode)	Bravo 25, 20 and 10	AC and DC	AC load	0	NA	NA	NA
UPS for AC loads	Sierra 10, 25 and XC	AC and DC	AC load and battery charging	1	Fall back mode 1	Fallback mode 1	Fallback mode 1
UPS for AC and DC loads	Sierra 10, 25 and XC	AC and DC	AC & DC load, and battery charging	1	Fallback mode 2	Fallback mode 2	Fallback mode 2
Rectifier	Sierra 10, 25 and XC	AC and DC	DC Load and battery charging	1	Fallback mode 2	Fallback mode 2	Fallback mode 2

## 7.4.2 Fallback mode

This mode will be activated when the modules lose communication with Inview. There are two modes available depending on the kind of system.

### Fallback mode 1:

- **CF1 Topology:**
  - UPS for AC loads
- **CF1066 Charging Voltage:**
  - Configure the voltage required on the DC port in fallback mode. Since the modules do not calculate temperature compensation once communication between the Inview controller and the module is lost. Consider the float voltage at the worst operating scenario.
- **CF1067 Charging Power:**
  - Maximum charging power is required for batteries in fallback mode. Set it according to the datasheet of the connected battery manufacturer.
- **CF1074 Max VDC Increment:**
  - By default, set it to 0. It doesn't have to be used for UPS for AC loads.

**Fallback mode 2:**

- **CF1 Topology:**
  - UPS for AC & DC loads or Rectifier is set
- **CF1066 Charging Voltage:**
  - Configure the voltage required on DC port in fallback mode. Since the modules do not calculate temperature compensation once communication between the Inview controller and the module is lost. Consider the float voltage at the worst operating scenario.
- **CF1067 Charging Power:**
  - Set the charging power to the maximum power required for charging the battery + Maximum power required for the connected DC load. If the power limit is unknown, set this value to the maximum power capacity of the system so that the DC loads are powered up at any time.
- **CF1074 Max VDC Increment:**
  - Voltage increment is used to recharge the battery in cV/min. Ensures the battery's maximum charging power is limited in fallback mode.
  - If the voltage has to increase rapidly, you can change this value. For example, configuring it to '6' will increase the DC port voltage to a maximum of 3.6V per hour.

**7.4.3 Phase Selection**

To configure the Single, Dual or Three phase of the system, In Advanced View, go to *Site > Energy System > Converter System > Configuration*.

In the System Section > ID CF6, enter the number of phases based upon the system input/output power.

*(Note: while configuring the AC phases, all the converters should be in OFF mode)*

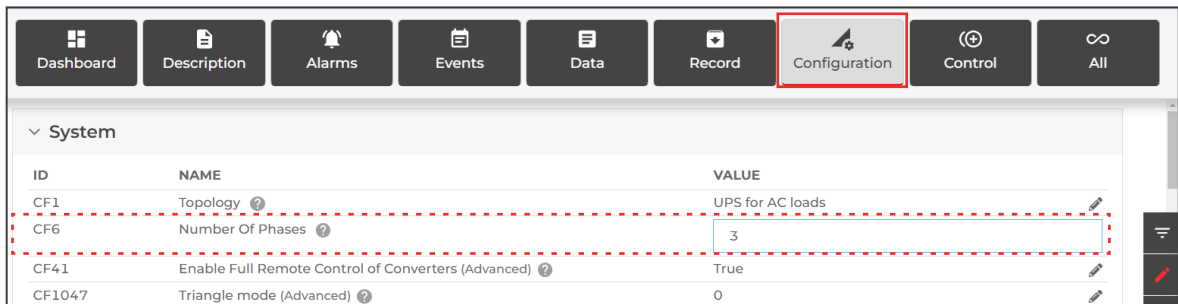

**7.4.4 AC Output Configuration**

To configure AC output parameters, In Advanced View, go to *Site > Energy System > Converter System > Configuration*.

In the AC Outputs section, enter the values for the corresponding parameter ID:

- **ID CF121:** enter the number of converters configured for phase 1(Installed power)
- **ID CF122:** enter the number of converters redundant for phase 1(Available power)
- **ID CF122:** enter the phase shift degree for phase 1
- Similarly, enter the values for phase 2 and 3

- ID CF1016: enter the nominal frequency

(Note: while configuring the AC phases, the converter should be in OFF mode)

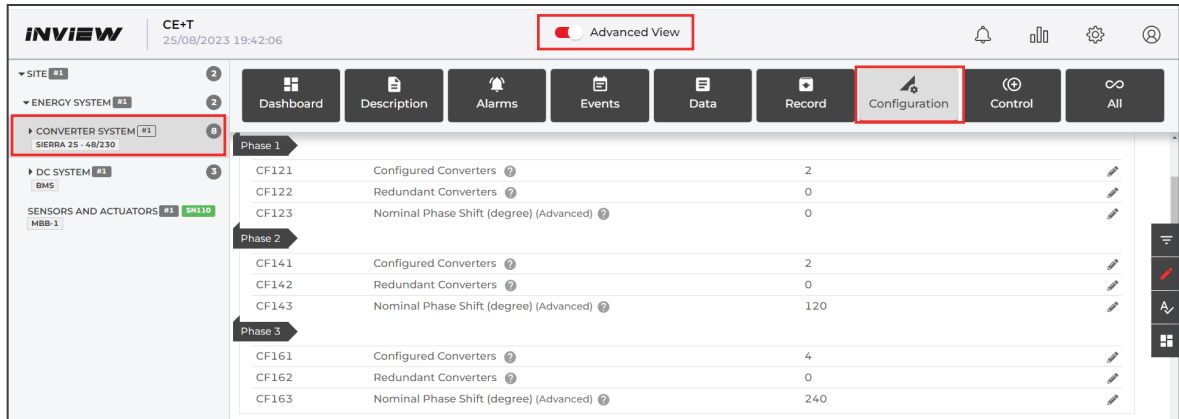

Phase	ID	Parameter	Value
Phase 1	CF121	Configured Converters	2
	CF122	Redundant Converters	0
	CF123	Nominal Phase Shift (degree) (Advanced)	0
Phase 2	CF141	Configured Converters	2
	CF142	Redundant Converters	0
	CF143	Nominal Phase Shift (degree) (Advanced)	120
Phase 3	CF161	Configured Converters	4
	CF162	Redundant Converters	0
	CF163	Nominal Phase Shift (degree) (Advanced)	240

### 7.4.5 Converters Configuration

If the system has more than one converter, it is better to start configuring with one converter on each phase.

1. Insert only one converter in the first phase of the system.

Go to *Advanced View > Site > Energy System > Converter System > Converter > Control*.

(Note: while assigning the phases of the converter, its AC output must be in OFF)

- a) Execute the ID CT12, to turn off the converter
- b) In the ID CT2, type “1” to set the converter ID and in the ID CT13 as “1” to assign phase 1
- c) After setting the values, click the  icon to execute that command

In this page, you can turn on/off the module or AC output and DC port of the module.

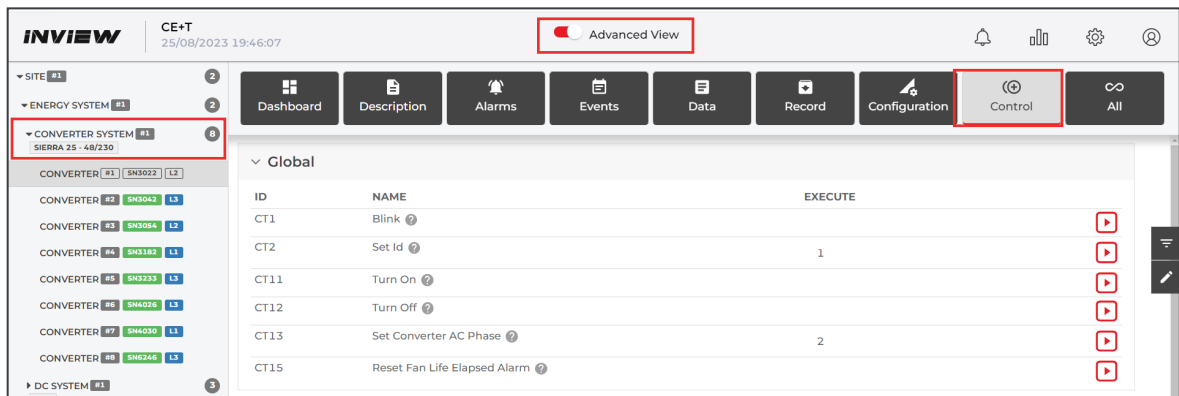

ID	NAME	EXECUTE
CT1	Blink	
CT2	Set Id	1
CT11	Turn On	
CT12	Turn Off	
CT13	Set Converter AC Phase	2
CT15	Reset Fan Life Elapsed Alarm	

To get an overview of the converter details, go to *Site > Energy System > Converter System > Converter > Dashboard*.

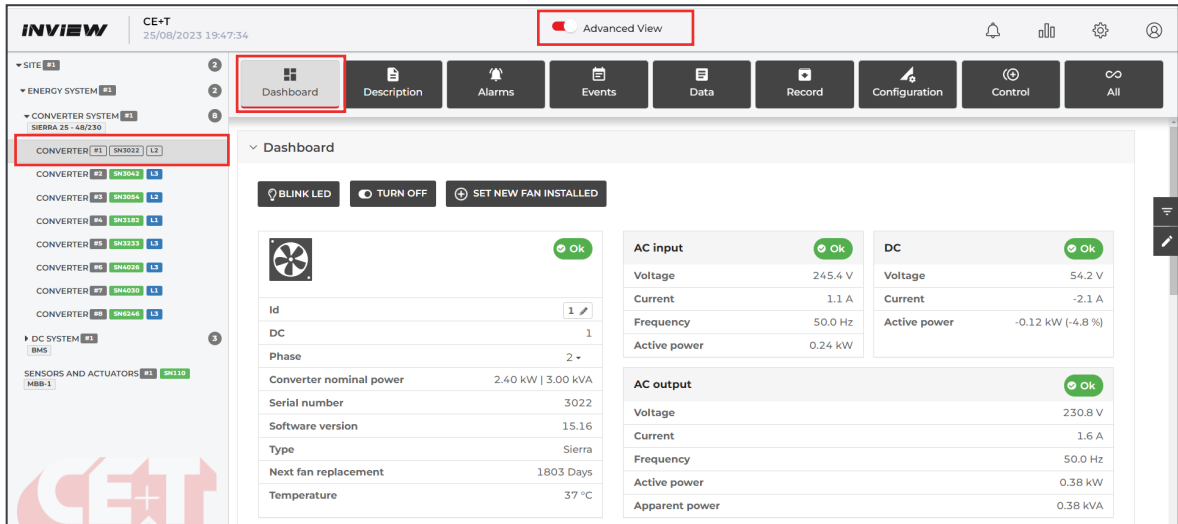

The screenshot shows the Inview web interface for a converter system. The top navigation bar includes 'Dashboard', 'Description', 'Alarms', 'Events', 'Data', 'Record', 'Configuration', 'Control', and 'All'. The 'Advanced View' toggle is highlighted in red. The main content area displays the 'Dashboard' for a specific converter, including buttons for 'BLINK LED', 'TURN OFF', and 'SET NEW FAN INSTALLED'. Below these are detailed specifications for AC input, DC, and AC output.

AC input	DC
Voltage: 245.4 V	Voltage: 54.2 V
Current: 1.1 A	Current: -2.1 A
Frequency: 50.0 Hz	Active power: -0.12 kW (-4.8 %)
Active power: 0.24 kW	

AC output
Voltage: 230.8 V
Current: 1.6 A
Frequency: 50.0 Hz
Active power: 0.38 kW
Apparent power: 0.38 kVA

In this page also you can modify the converter ID and Phase number.

#### Other Features:

- **Blink LED:** Clicking on “BLINK LED” button, the corresponding converter LED’s blink for 6 seconds. It helps to identify the converter in the system and also the assigned phase of the converter.
- **Turn Off:** Clicking on “TURN OFF” button, the corresponding converter will be turned OFF and generates an alarm in events page as converter off.
- **Set new fan installed:** Clicking on “SET NEW FAN INSTALLED” button, the corresponding converter “Module fan replacement” due will be reset to 2556 days (7 years).

(Note: Do not click this button, until a new fan is replaced inside the converter.)

2. If it is a single-phase system, insert the remaining converters and set module ID and assign them to phase 1.

#### Perform the following procedure for the multiphase system

3. Insert the second converter in phase 2, and set the Converter ID as “2,” and assign it “Phase 2”
4. Insert the third converter in phase 3, and set the Converter ID as “3,” and assign it “Phase 3.”
5. Repeat the process for remaining converters by adding one converter in each phase.
6. After configuring all the converters, turn ON all the converters.  
To turn on all the converters, go to *Advanced View > site > Converter System > Control and execute CT41 parameter*.

### 7.4.6 DC Configuration

Go to *Advanced View > Site > Energy System > DC System > Configuration*

In the DC Bus section, set the parameters depending upon the DC voltage. The below page is configured to 48 Vdc.

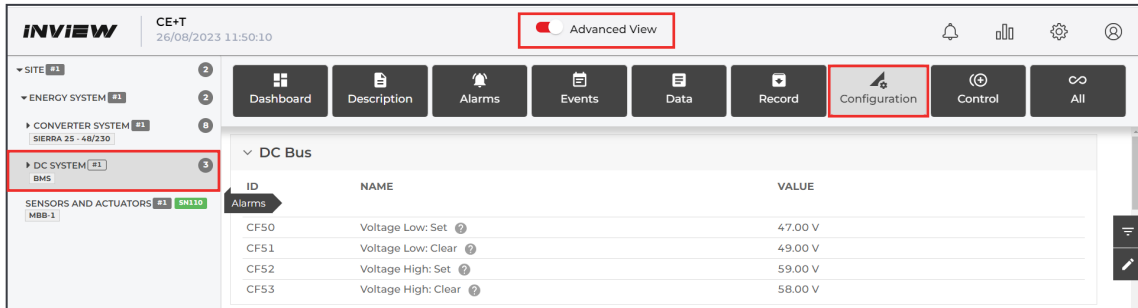

The screenshot shows the INVIEW interface for DC Bus configuration. The 'Advanced View' toggle is active. The left sidebar shows the navigation path: SITE #1 > ENERGY SYSTEM #1 > CONVERTER SYSTEM #1 (SIERRA 25 - 48/230) > DC SYSTEM #1 (BMS). The main content area displays a table for DC Bus parameters:

ID	NAME	VALUE
CF50	Voltage Low: Set	47.00 V
CF51	Voltage Low: Clear	49.00 V
CF52	Voltage High: Set	59.00 V
CF53	Voltage High: Clear	58.00 V

### 7.5 Battery Configuration

The battery page provides access and configures battery parameters such as battery characteristics, LVD, temperature compensation, boost charging, and test.

Battery configuration page is applicable only for the following topology designed system.

- UPS for AC loads
- UPS for AC and DC loads

Make sure the ID CF1071 is set as “1” to configure Sierra converter. (Access to CF1071: *Advanced View > Site > Energy System > System > Configuration > DC > Modes*)

Go to *Advanced View > Site > Energy System > DC System > Configuration*.

In the Battery section, enter the details of the battery connected to the system such as Battery Characteristics, Autonomy, float voltage, Current limitation, Temperature, Temperature compensation, Boost and Test.

**Note:** In this page, the parameters are configured with default values. While modifying the parameters, it is recommended to enter the values as per the system DC voltage and battery datasheet.

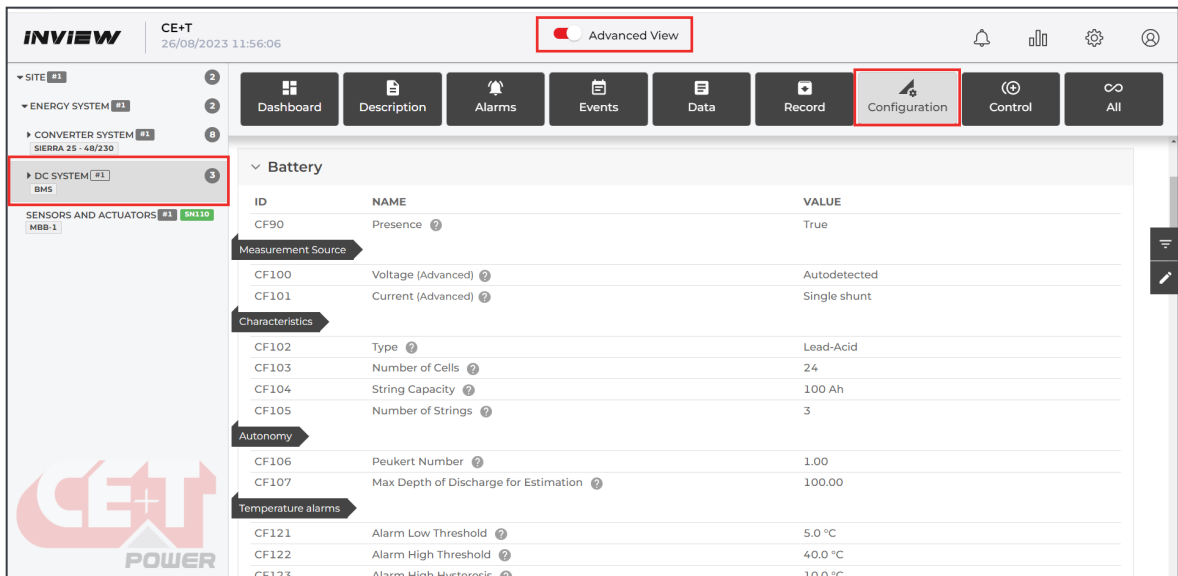

The screenshot shows the INVIEW interface for Battery configuration. The 'Advanced View' toggle is active. The left sidebar shows the navigation path: SITE #1 > ENERGY SYSTEM #1 > CONVERTER SYSTEM #1 (SIERRA 25 - 48/230) > DC SYSTEM #1 (BMS). The main content area displays a table for Battery parameters:

ID	NAME	VALUE
CF90	Presence	True
<b>Measurement Source</b>		
CF100	Voltage (Advanced)	Autodetected
CF101	Current (Advanced)	Single shunt
<b>Characteristics</b>		
CF102	Type	Lead-Acid
CF103	Number of Cells	24
CF104	String Capacity	100 Ah
CF105	Number of Strings	3
<b>Autonomy</b>		
CF106	Peukert Number	1.00
CF107	Max Depth of Discharge for Estimation	100.00
<b>Temperature alarms</b>		
CF121	Alarm Low Threshold	5.0 °C
CF122	Alarm High Threshold	40.0 °C
CF123	Alarm High Hysteresis	10.0 °C



### 7.5.1 Measurement Source

Select any one option for battery voltage and current based upon the battery source in the ID CF100 and CF101, respectively.

- *Auto Detected*: It detects automatically based upon the voltage and current measurement
- Select “*Single probe*”, if MBB measures the DC values
- Select “*Modules*”, if MBB is not installed
- Select “*Smart Batteries*”, if BMS of the battery measures the DC values

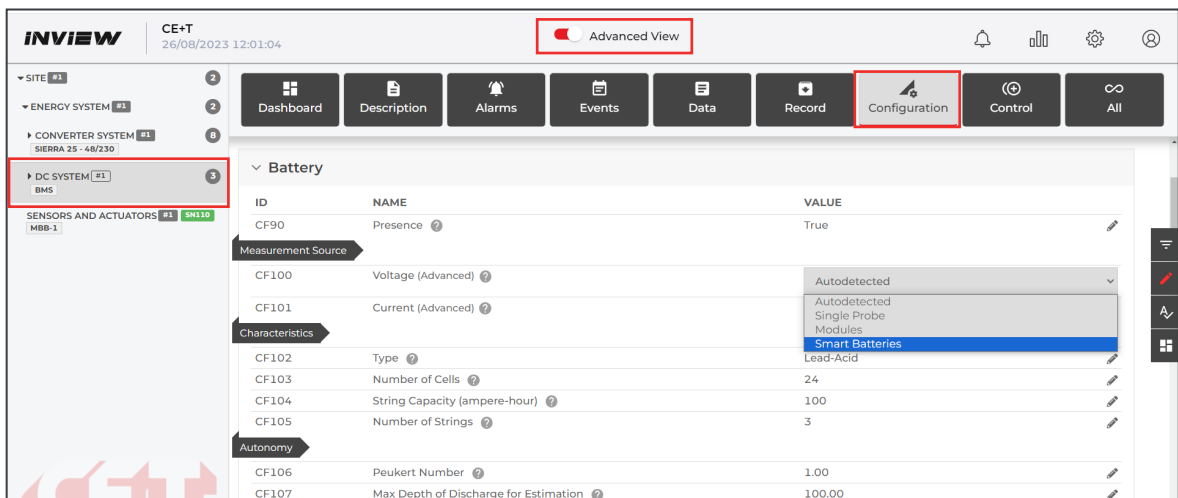

### 7.5.2 Battery Disconnect or LVD

The LVD in the CE+T system works as bistable only, and it prevents batteries from discharging beyond the threshold voltage. It is installed in-line between the load and the battery. On this page, the parameters are configured with default values. Users can modify it as per the LVD installed in the system.

Go to [Advanced View](#) > [Site](#) > [Energy System](#) > [DC System](#) > [Configuration](#)

In the *Battery Disconnect* section, enter the details of LVD connected to the system.

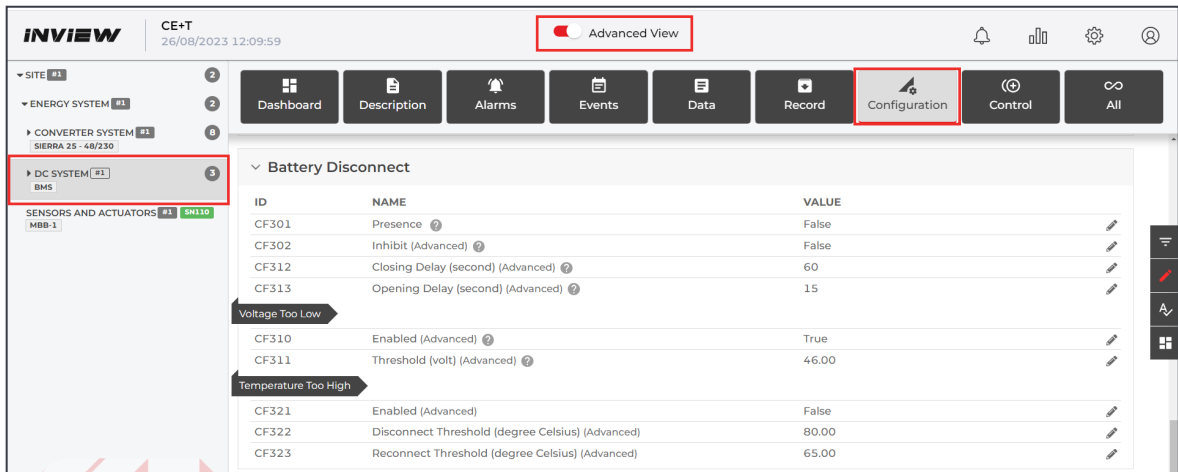

Refer to the section “Relay Configuration”, page 48 for further LVD bistable relay/shunt settings.



### 7.6.1 MBB Configuration

Before configuring MBB, go to *Advanced View > Site > Energy System > DC System > Configuration > Battery* and in the *Measurement Source* section, make sure the ID CF100 is set to “Single probe” and ID CF101 to “Single shunt”.

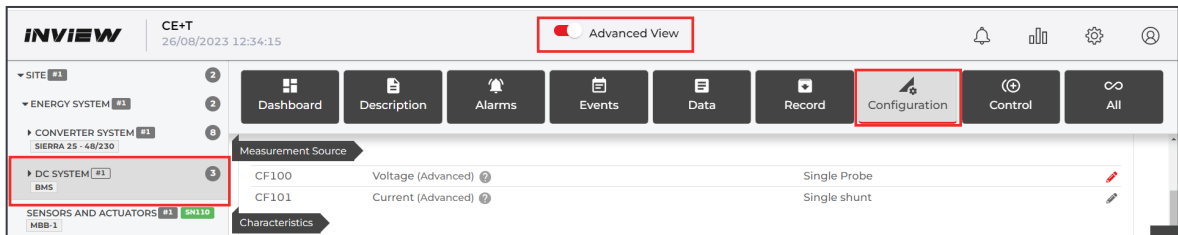

To configure MBB, go to *Advanced View > Site > Sensors and Actuators > Configuration*.

1. **Voltage section:** select an option for the V1, V2 and V3 from the drop-down list in the ID CF101, CF106, and CF111, respectively.

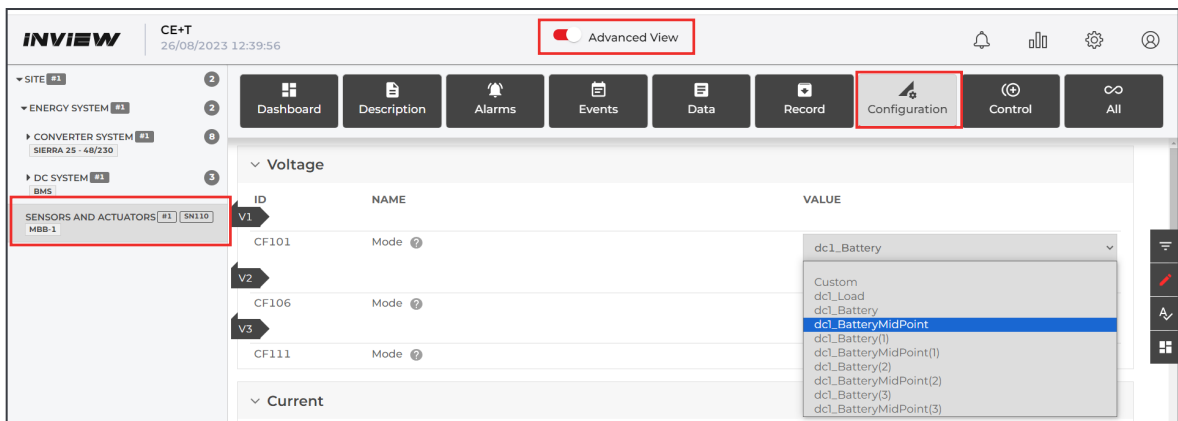

- **dc1\_Load:** to measure voltage of DC load
- **dc1\_Battery:** to measure the voltage of battery
- **dc1\_BatteryMidPoint:** to measure the DC voltage between the batteries midpoint by using V2 and V3

2. **Current section:** select an option for the I1, I2 and I3 from the drop-down list in the ID CF201, CF206 and CF211, respectively.

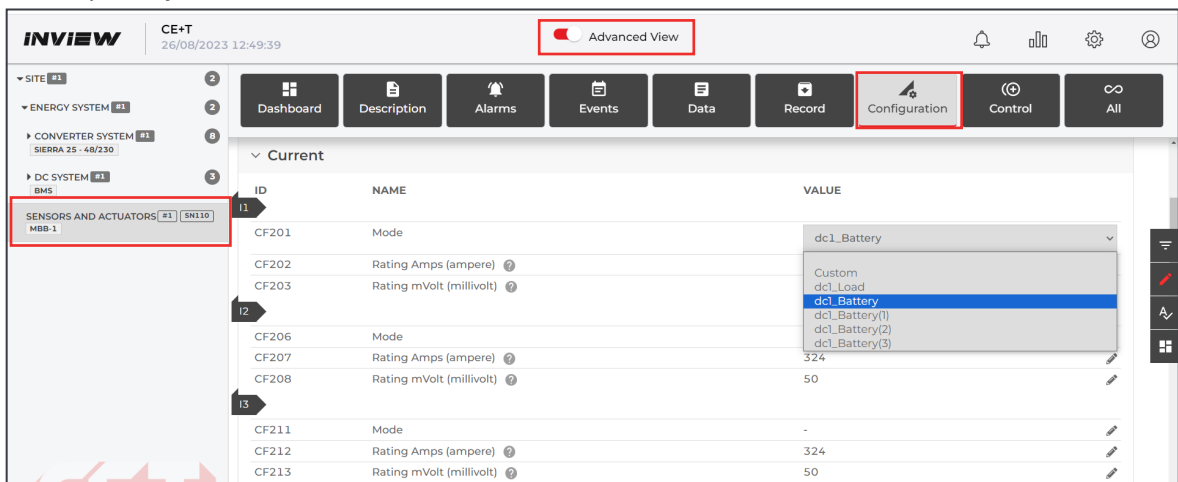

- **dc1\_Load**: to measure the current of DC load
  - **dc1\_Battery**: to measure the current of battery
  - Enter the corresponding rating values of shunt
3. **Temperature section**: select an option for the T1 and T2 from the drop-down list in the ID CF301 and CF306, respectively.

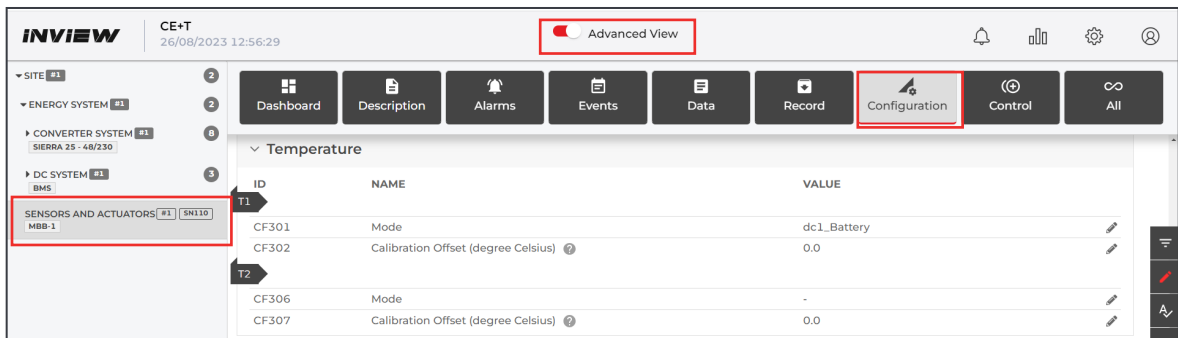

- **dc1\_Battery**: to measure the temperature of battery
  - **dc1\_Ambient**: to measure the ambient temperature of battery
4. **Relay Configuration**: The MBB has six relays and configured as below:
- K1 and K2 are configured to Minor and Major alarms
  - K3 and K4 can be configured to any desired alarms or digital inputs

**Example: Assigning a relay to the digital input**

- Go to K3 relay and select the following options
  - ID CF411: select the mode as “Custom”
  - ID CF412: select the Default state as “Energized” or “De-energized”
  - ID CF413: enter the formula as “@(sa1\_data501)”
- (Sa1: Sensors and Actuators, data501: Data section, Digital input D1 (DA501))
- After selecting the options, click “APPLY AND SAVE” in the modification list

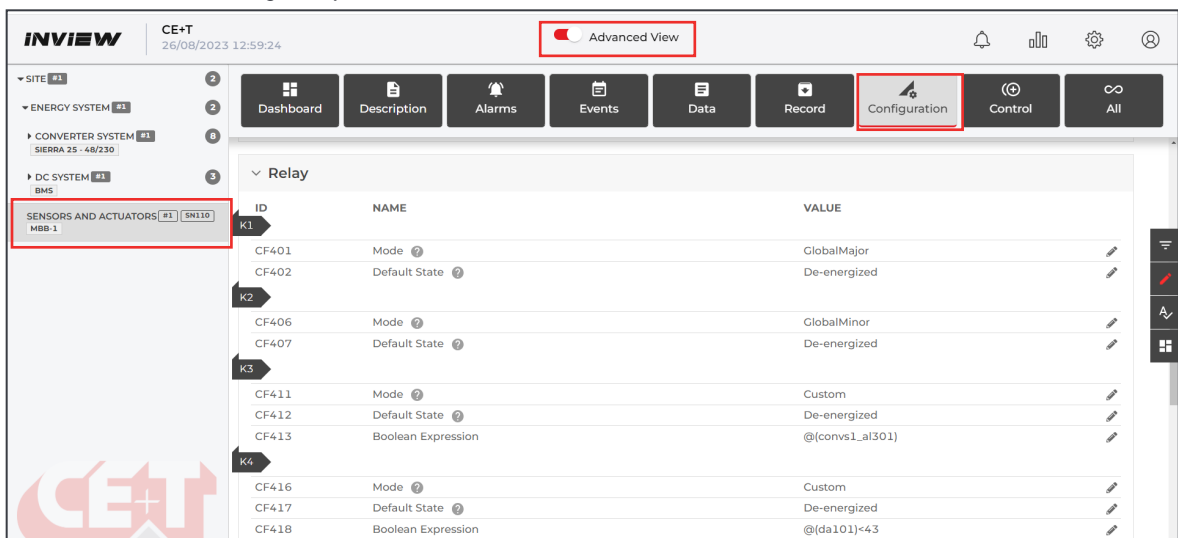

- K5 and K6 are configured to latch or non-latch LVD, if used
  - **Relay section:** select an option for K5 and K6 from “Mode” drop down list
  - For latch LVD, select the ID CF421 as “dc1\_LvdLatchClose” and CF426 as “dc1\_LvdLatchOpen” or vice versa, but must not assign the same value for both relays.
  - For non-latch LVD, select the ID CF421 as “dc1\_Lvd”
  - Select Default State as “De-energized”

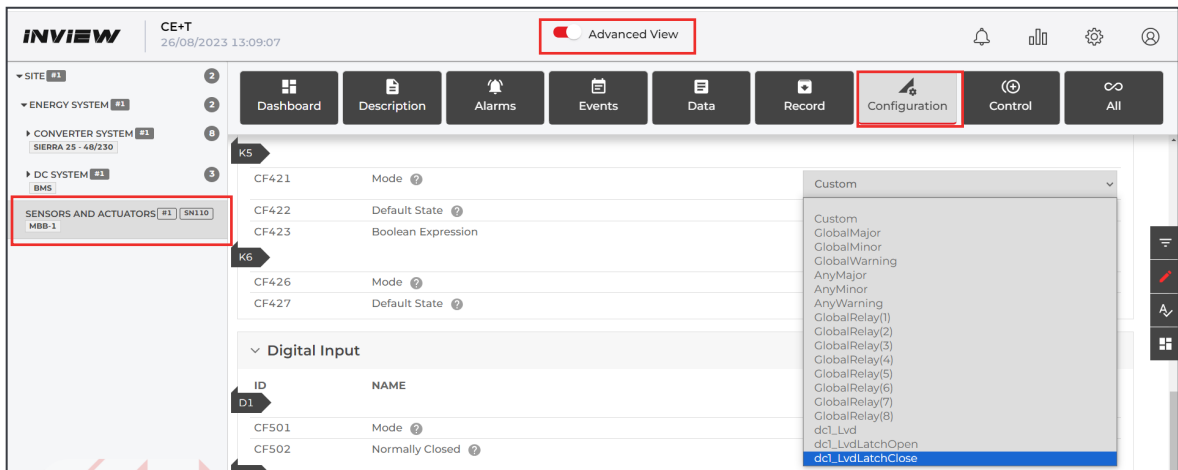

### 5. Digital Inputs

- To know LVD status, connect the auxiliary contact to the Digital Input 6. The ID CF526 is to select as “dc1\_LvdState”

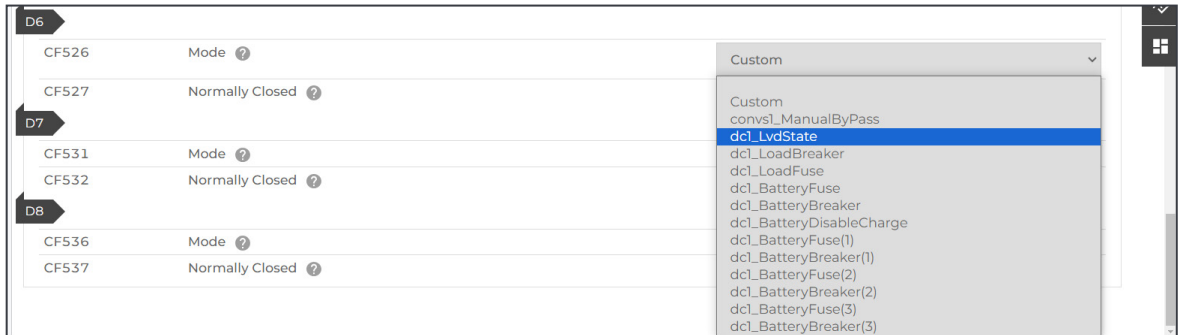

The below connection diagram is an example of LVD Auxiliary contact.

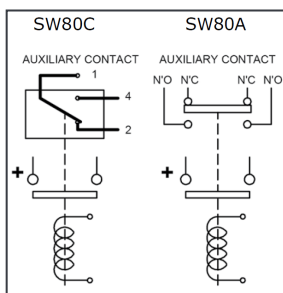

## 7.7 Manual Bypass Configuration

The manual by-pass is a manually operated switch, and it is used to transfer the load from normal to by-pass without interruption. When the system is in by-pass, the load is subjected to AC main disturbances. The standard manual by-pass is “Make before Break”. The MBP auxiliary contact must be connected to the Inview Digital input 1.

Go to [Advanced View](#) > [Site](#) > [Configuration](#) and scroll down to the Digital Input section. In the ID CF501, select the “convS1\_ManualByPass” from the drop down list.

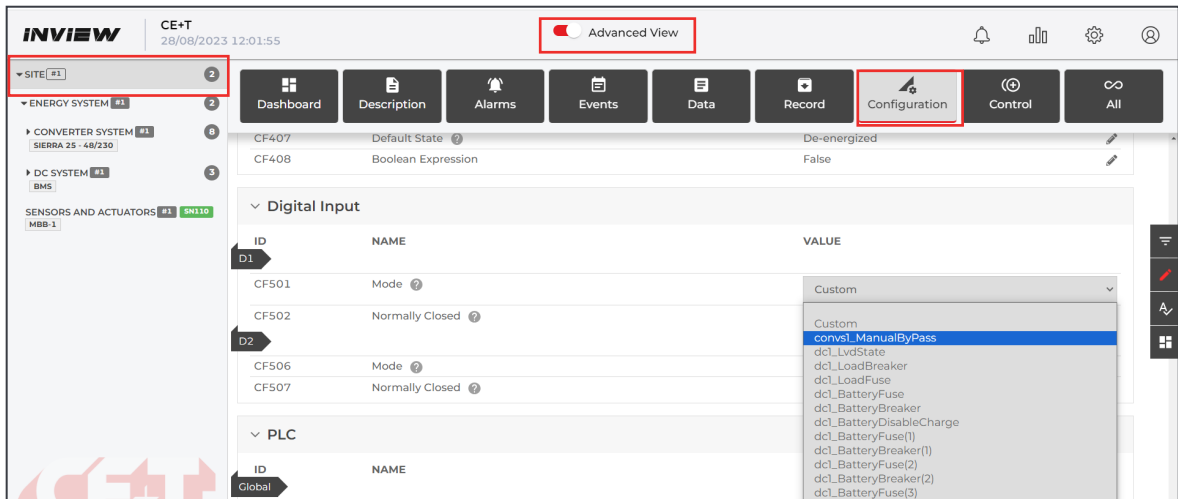

The screenshot shows the Inview web interface in 'Advanced View' mode. The left sidebar shows a navigation tree with 'SITE #1' selected. The main content area has a top navigation bar with 'Configuration' highlighted. Below this, there are sections for 'Digital Input' and 'PLC'. In the 'Digital Input' section, a table lists inputs CF501 through CF507. For CF501, the 'VALUE' column has a dropdown menu open, showing 'Custom' selected and 'convS1\_ManualByPass' highlighted. Other options in the dropdown include 'dc1\_LvldState', 'dc1\_LoadBreaker', 'dc1\_LoadFuse', 'dc1\_BatteryFuse', 'dc1\_BatteryBreaker', 'dc1\_BatteryDisableCharge', 'dc1\_BatteryFuse(1)', 'dc1\_BatteryBreaker(1)', 'dc1\_BatteryFuse(2)', 'dc1\_BatteryBreaker(2)', and 'dc1\_BatteryFuse(3)'.

*Note: For more information about MBP auxiliary connection with remote ON/OFF, refer to the system user manual.*

## 7.8 Module Remote ON/OFF

The AC and DC output of the system and also each module in the system can be turned ON/OFF in two ways:

1. Remote ON/OFF terminal at rear side of the shelf or on a junction kit for Sierra XC parallelization: will impact only AC output.
2. Through web interface
  - Systems Level
    - Both AC and DC: [Advanced View](#) > [Converter system](#) > [Control](#) > [System](#) section > CT41 and CT42
    - AC Only: [Advanced View](#) > [Converter system](#) > [Control](#) > [AC Outputs](#) section > CT101and CT102
    - DC Only: [Advanced View](#) > [Converter system](#) > [Control](#) > [DC](#) section > CT511and CT512

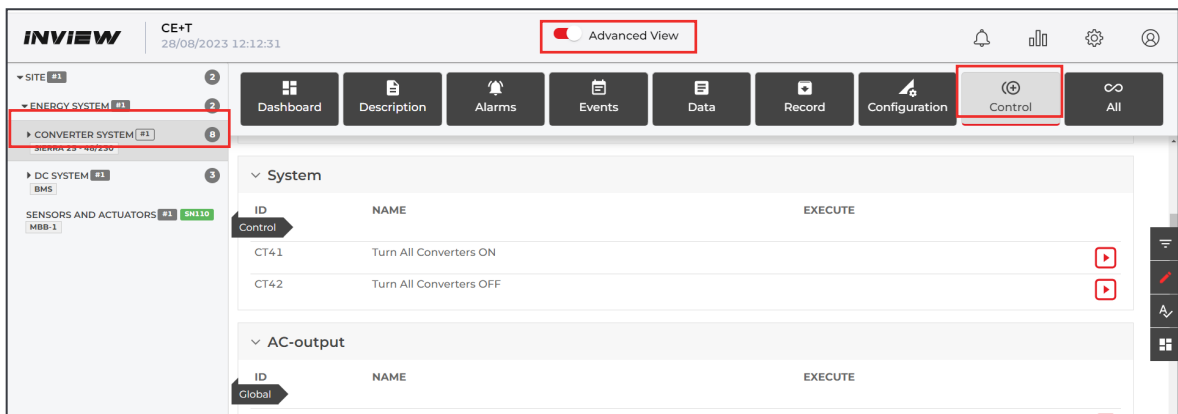

The screenshot shows the Inview web interface in 'Advanced View' mode. The left sidebar shows 'CONVERTER SYSTEM #1' selected. The main content area has a top navigation bar with 'Control' highlighted. Below this, there are sections for 'System' and 'AC-output'. The 'System' section contains a table with columns 'ID', 'NAME', and 'EXECUTE'. It lists 'Control' as a header, followed by 'CT41 Turn All Converters ON' and 'CT42 Turn All Converters OFF', each with a red play button icon. The 'AC-output' section also has a table with columns 'ID', 'NAME', and 'EXECUTE', showing 'Global' as a header and 'CT101 Turn All Converters ON' below it.

- Module Level
  - Both AC and DC: *Advanced View > Converter system > Converter > Control > Global > CT11 and CT12*
  - AC Only: *Advanced View > Converter system > Converter > Control > AC output > CT21 and CT22*
  - DC Only: *Advanced View > Converter system > Converter > Control > DC > CT31 and CT32*

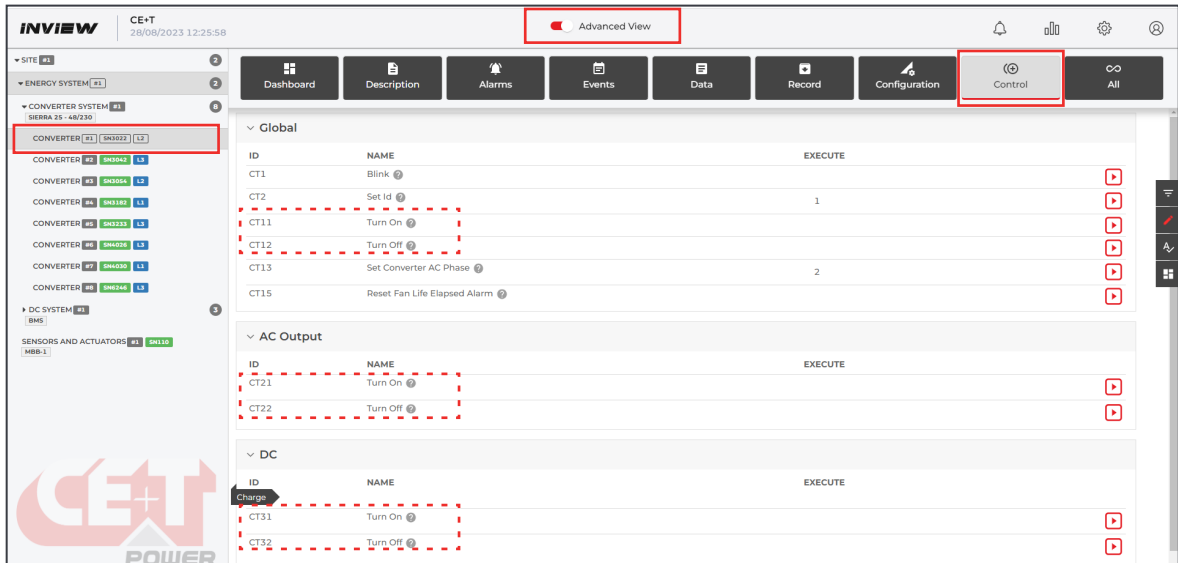

The screenshot shows the Inview software interface for power system settings. The top navigation bar includes 'Advanced View' and a 'Control' tab. The left sidebar shows a tree view with 'CONVERTER SYSTEM' expanded to 'CONVERTER'. The main content area is divided into three sections: Global, AC Output, and DC. Each section contains a table of control actions with columns for ID, NAME, and EXECUTE. Red dashed boxes highlight specific control actions in each section.

ID	NAME	EXECUTE
CT1	Blink	
CT2	Set Id	1
CT11	Turn On	
CT12	Turn Off	
CT13	Set Converter AC Phase	2
CT15	Reset Fan Life Elapsed Alarm	

ID	NAME	EXECUTE
CT21	Turn On	
CT22	Turn Off	

ID	NAME	EXECUTE
Charge		
CT31	Turn On	
CT32	Turn Off	

## 7.9 Widgets Configuration

Widgets of different sorts are available. Up to 20 widgets can be configured on the home page. The configuration will appear both on the web interface and the LCD touch screens. Before configuration, ensure the default home page is Widgets. Refer to the section “7.3.4 Home Page Settings”, page 38.

Perform the following step for Widgets configuration:

1. **Assigning number of widgets:** Go to *Advanced View > Energy System > Description > Connected Assets*. Click the edit icon and enter the number of assets connected to the system in the ID DE500. Click “Apply and Save” to apply changes.

For example, the Sierra System has four assets: AC Input, Battery, AC Load and DC Load. So, in the below screenshot, the number 4 is entered.

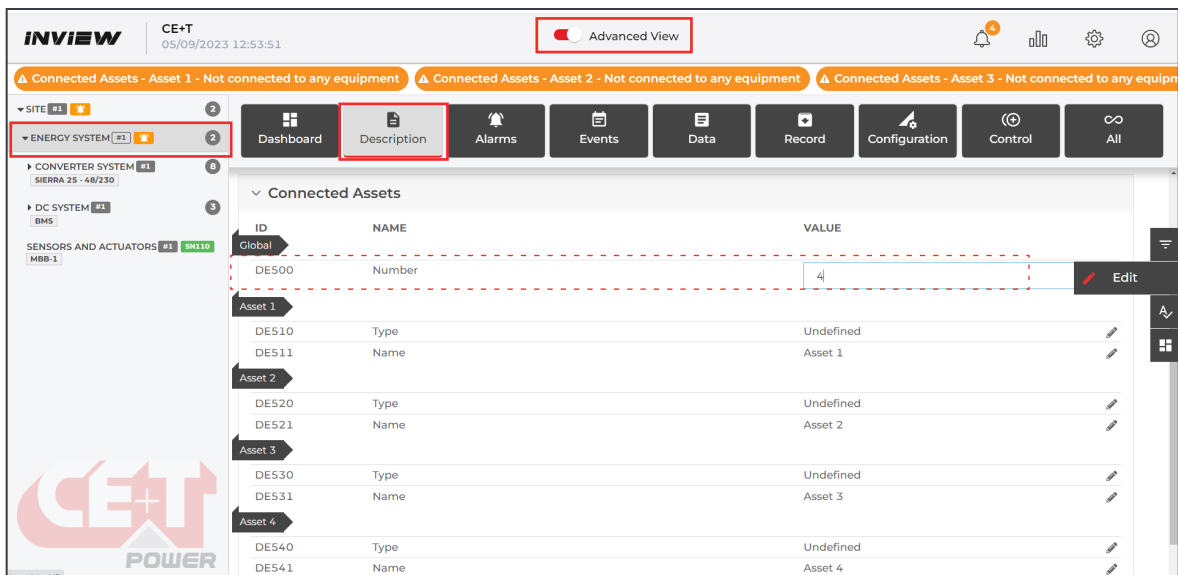

ID	NAME	VALUE
Global		
DE500	Number	4
Asset 1		
DE510	Type	Undefined
DE511	Name	Asset 1
Asset 2		
DE520	Type	Undefined
DE521	Name	Asset 2
Asset 3		
DE530	Type	Undefined
DE531	Name	Asset 3
Asset 4		
DE540	Type	Undefined
DE541	Name	Asset 4

**Note:** As soon as you start customizing your assets, the default one will be deleted, and you have to create all the assets you want to display. You can get the default assets back by setting DE500 to 0 again.

2. **Widget settings:** Go to Asset 1 in the ID DE510, select the type of widget and enter the desired name for the widget in ID DE511.

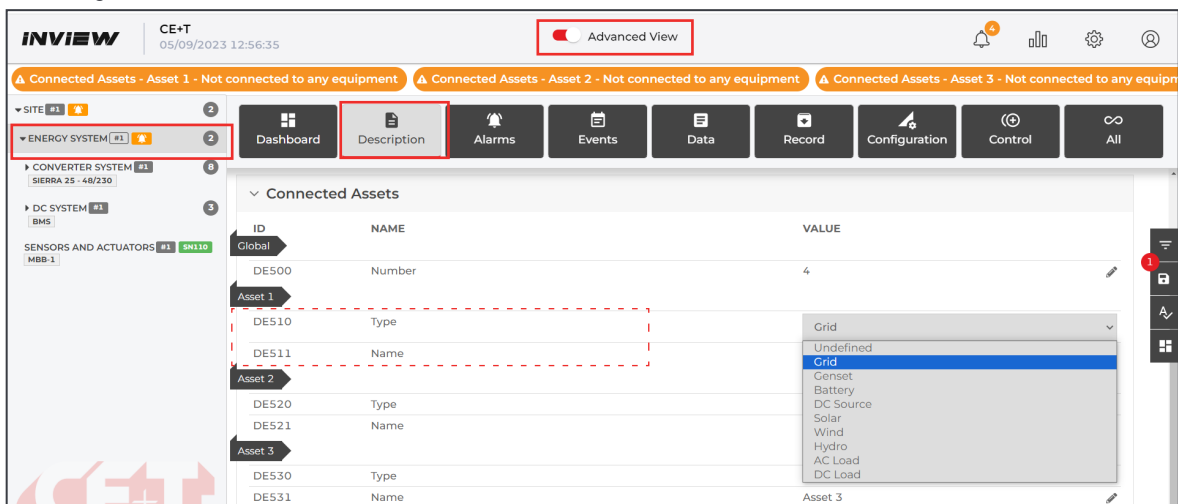

ID	NAME	VALUE
Global		
DE500	Number	4
Asset 1		
DE510	Type	Grid
DE511	Name	
Asset 2		
DE520	Type	Undefined
DE521	Name	Asset 2
Asset 3		
DE530	Type	Undefined
DE531	Name	Asset 3



a) Similarly, configure for other remaining Assets.

S.No	Asset Name	Asset Type ID	Asset Name ID
1	Asset 1	DE510	DE511
2	Asset 2	DE520	DE521
3	Asset 3	DE530	DE531
4	Asset 4	DE540	DE541
N	Asset N	DE5N0	DE5N1

In the below screen shots, Assets 1, 2, 3 and 4 are assigned for AC Input, Battery, AC Loads and DC Loads, respectively.

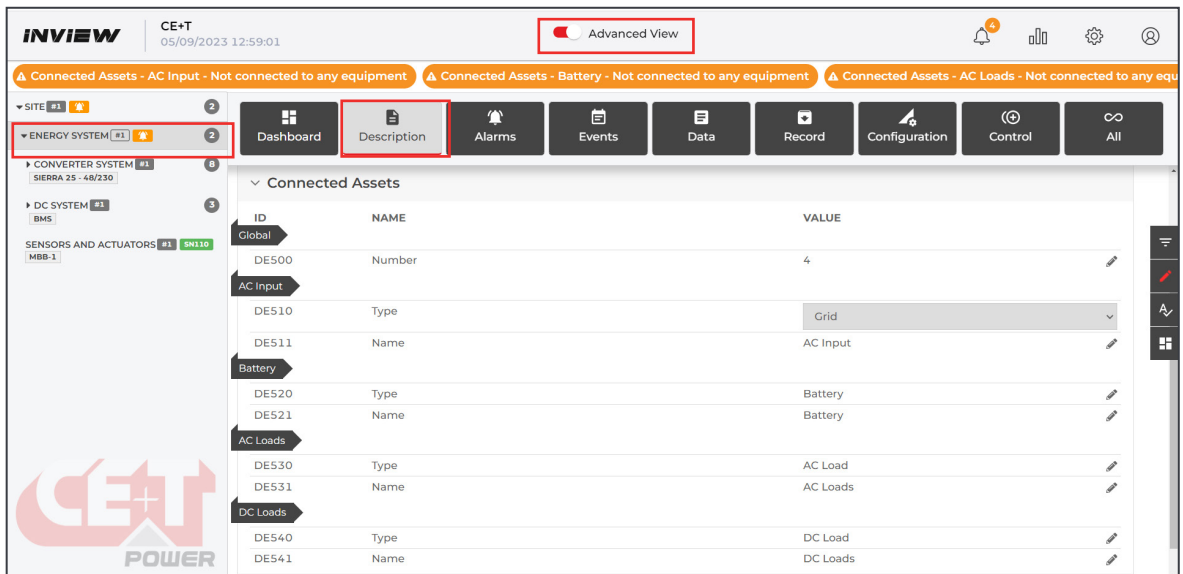

The screenshot shows the Inview software interface. The 'Advanced View' toggle is turned on. The 'Description' tab is selected, showing a table of 'Connected Assets' with columns for ID, NAME, and VALUE. The assets are categorized by type: Global, AC Input, Battery, AC Loads, and DC Loads. Red boxes highlight the 'Description' tab and the 'Advanced View' toggle.

ID	NAME	VALUE
Global		
DE500	Number	4
AC Input		
DE510	Type	Grid
DE511	Name	AC Input
Battery		
DE520	Type	Battery
DE521	Name	Battery
AC Loads		
DE530	Type	AC Load
DE531	Name	AC Loads
DC Loads		
DE540	Type	DC Load
DE541	Name	DC Loads

b) Toggle the Advanced view switch and verify all assigned widgets appear on the home page.

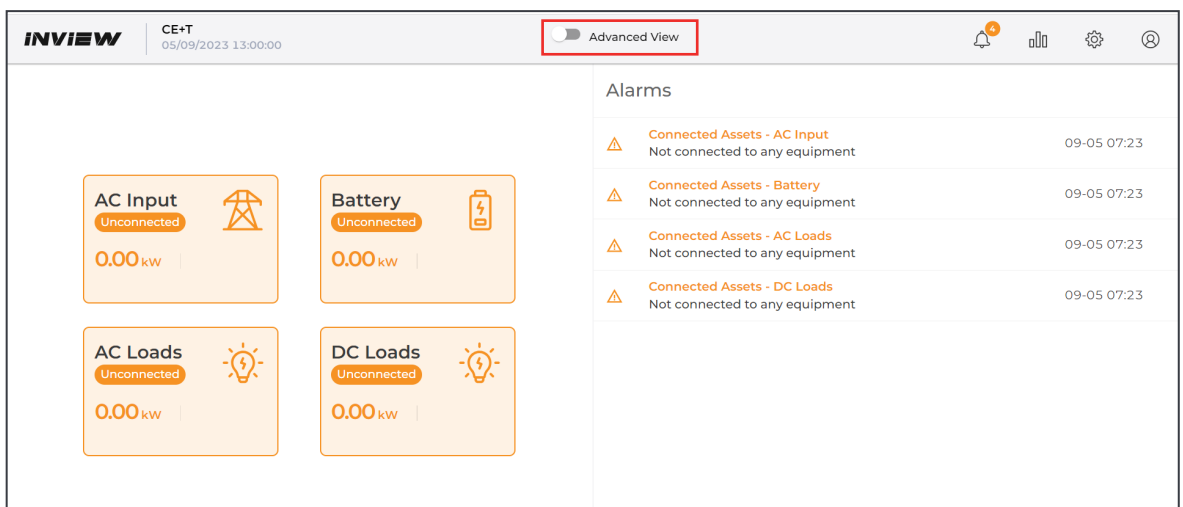

The screenshot shows the Inview software interface with the 'Advanced View' toggle turned off. The home page displays four widgets for 'AC Input', 'Battery', 'AC Loads', and 'DC Loads', all showing '0.00 kW' and 'Unconnected' status. An 'Alarms' section on the right lists four alerts: 'Connected Assets - AC Input', 'Connected Assets - Battery', 'Connected Assets - AC Loads', and 'Connected Assets - DC Loads', all with the message 'Not connected to any equipment' and a timestamp of '09-05 07:23'. Red boxes highlight the 'Advanced View' toggle and the 'Alarms' section.

In Widget settings, the type and name are assigned to the widget, which is not connected to the appropriate measurements. Follow the next step for connections.

3. **Widget Connections:** Each asset should be linked to a system node to get the real measurements. The different nodes possible with respect to the types are given in the following table. Choose the one that best matches your widget type among the possible links, depending on your system topology.

S.No	Widget	Type	Convention Type	Links to Measurements
1		Grid	Source	<a href="#">Converter System &gt; Description &gt; Asset Connections &gt; DE502 (AC Input)</a>
2		Genset	Source	<a href="#">Converter System &gt; Description &gt; Asset Connections &gt; DE502 (AC Input)</a>
3		DC Source	Source	<a href="#">Converter System &gt; Description &gt; Asset Connections &gt; DE503 DC</a> <a href="#">DC Converter System &gt; Description &gt; Asset Connections &gt;</a> <ul style="list-style-type: none"> <li>• <a href="#">DE501 DC Internal</a></li> <li>• <a href="#">DE502 DC External</a></li> </ul>
4		Solar	Source	<a href="#">Solar Power System &gt; Description &gt; Asset Connections &gt;</a> <ul style="list-style-type: none"> <li>• <a href="#">DE501 (AC Outputs)</a></li> <li>• <a href="#">DE503 (DC)</a></li> </ul>
5		Battery	Load	<a href="#">DC System &gt; Description &gt; Asset Connections &gt; DE505 (Battery)</a>
6		AC Load	Load	<a href="#">Converter System &gt; Description &gt; Asset Connections &gt;</a> <ul style="list-style-type: none"> <li>• <a href="#">DE501 (AC Outputs)</a></li> <li>• <a href="#">DE502 (AC Inputs)</a></li> </ul> <a href="#">Energy System* &gt; Description &gt; Asset Connections &gt; DE501 (AC Outputs)</a>  *Shall be used for systems with PV inverter connected to the AC output. It considers the PV production in the computation of the load value.
7		DC Load	Load	<a href="#">DC System &gt; Description &gt; Asset Connections &gt; DE504 DC Load</a>

Go to *Advanced View > Converter System > Description > Asset Connections*.

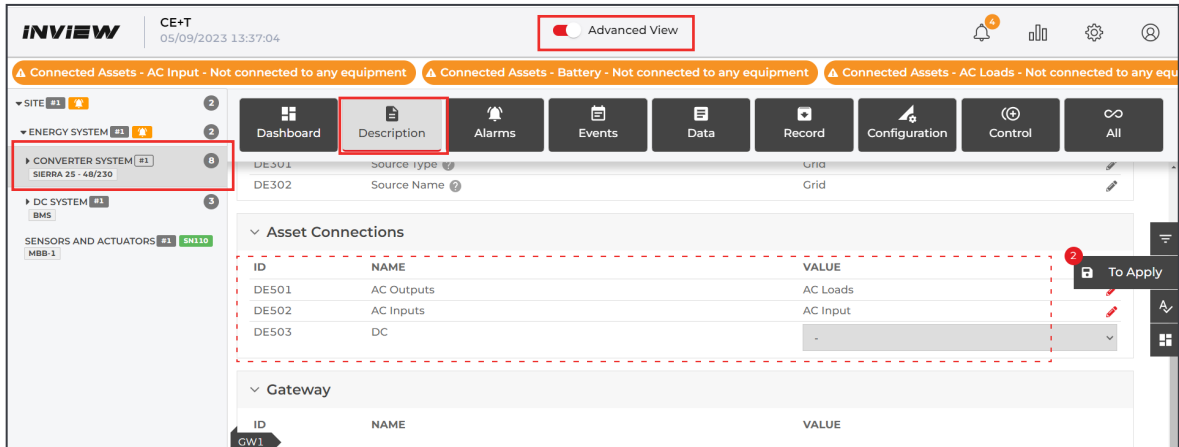

- **AC Outputs:** In the ID DE501, Select the Asset name from the list connected to the system’s AC Output, like AC load or renewable sources. The “AC Loads” is selected in the screen shot above, which is the Asset name of the ID DE531. Refer to the screen shot on page 53.
- **AC Inputs:** In the ID DE502, Select the Asset name from the list connected to the system’s AC Input, such as Grid, Genset, Solar, Wind power, Hydro power, etc. The “AC Input” is selected in the screen shot above, which is the Asset name of the ID DE511. Refer to the screen shot on page 53.
- **DC:** In the ID DE503, Select the Asset name from the list connected to the system’s DC Input, such as Rectifier, MPT, etc. No DC input is connected to the system, so in the above screen shot, it is left blank.
- **DC Load and Battery:** Go to *Advanced View > DC System > Description > Asset Connections*.

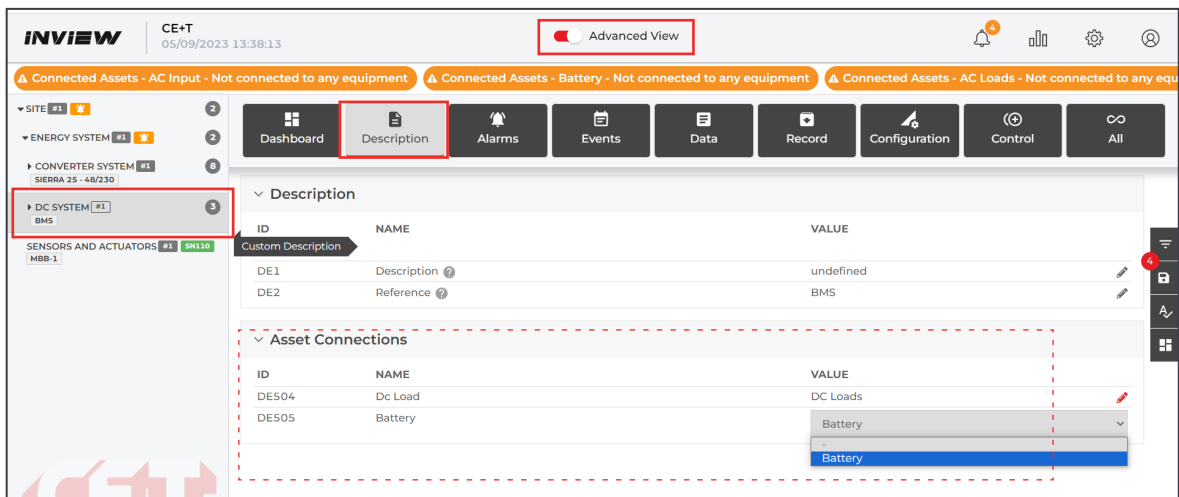

- **DC Load:** In the ID DE504, Select the Asset name from the list connected to the system’s DC Output, like DC load. The “DC Loads” is selected in the screen shot above, which is the Asset name of the ID DE541. Refer to the screen shot on page 53.
- **Battery:** In ID DE505, Select the Asset name of the **Battery** from the list connected to System. The “Battery” is selected in the screen shot above, which is the Asset name of the ID DE521. Refer to the screen shot on page 53.

- Toggle the Advanced view switch and verify all assigned widgets are configured correctly on the home page.

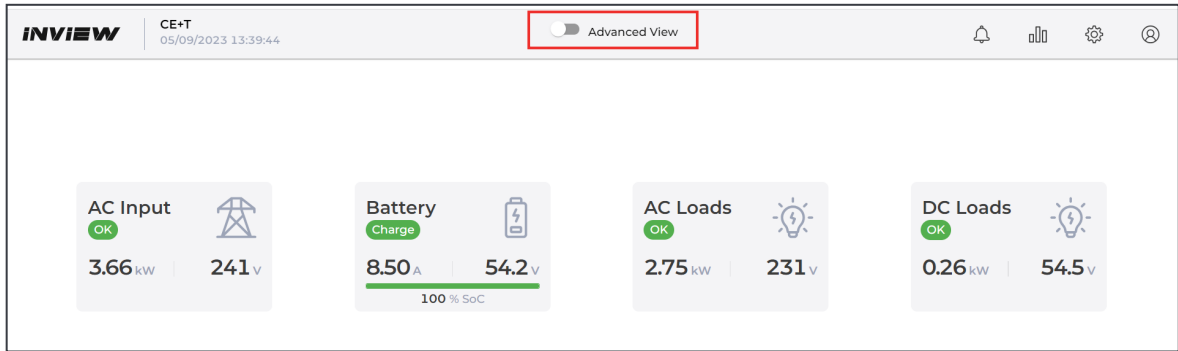

## 7.10 Communication Protocol

### 7.10.1 Modbus

Modbus over TCP/IP is available, and it has both read and write mode, which means that Modbus can be used for monitoring and execute actions on the system. (Note: The write option is only available with the Operation license.)

Port is fixed to standard Modbus TCP/IP port 502. This protocol can be either enabled or disabled.

For the Modbus configuration, go to *Advanced View > Site > Configuration*, scroll down to the *Modbus* section and select the following options. It is also possible to filter on 'Modbus' - Use the filter button on the right.

In the ID CF155, select "True" to enable the Modbus TCP/IP function.

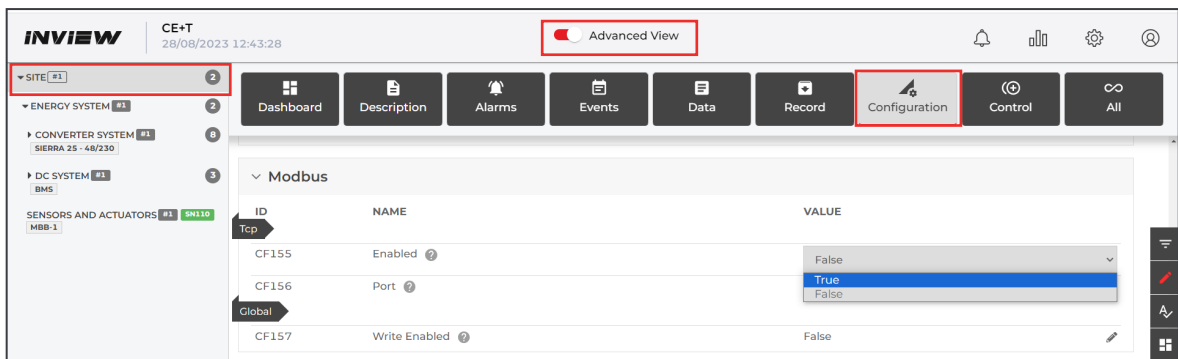

The following device/equipment mapping has been defined:

Device ID	Equipment
1	DC System 1
2	DC System 2
3	DC System 3
4	DC System 4
11	Inverter System 1
12	Inverter System 2

Device ID	Equipment
13	Inverter System 3
14	Inverter System 4
21	DC/DC Converter (Iris)
31	Converter System 1
32	Converter System 2
33	Converter System 3
34	Converter System 4
91	Energy System 1
100	Site
101	Sensors And Actuators 1
102	Sensors And Actuators 2

When the equipment does not exist, it will respond with function code 4.

- Each **discrete input** is associated with the alarm of the equipment, with the same id. Reading 1 means that the alarm is active.
- Each **input register** corresponds to the data of the equipment. All these values are coded assigned 16 bit. A correction factor is often applied. All the values are not available (like strings. Some status are coded as uint)
- Each **discrete coil** corresponds to the entries for controlling the equipment. It supports only simple control, without any parameters.
- Each **holding register** corresponds to the configuration of the equipment. It only supports entries that can be read and of numeric type. It includes advanced controls with parameters, complimentary with discrete coils.

The Modbus transport layer is Ethernet over TCP/IP. The default used port is 502:

- Discrete Inputs, alarm reading (Read Only), using modbus command 02
- Input Registers, data reading (Read Only), using modbus command 04
- Discrete Coils Table (Command), using modbus command 05
- Holding registers, using modbus command 03 for multiple read, and 06 for a single write

If you want to use Modbus to monitor other types of systems, please contact us. We will study the business case and make a proposal.

To download the Modbus data, log in to the Inview web interface, go to *Administration > Files > MMI References* and click the Modbus Map “**Export**” button.

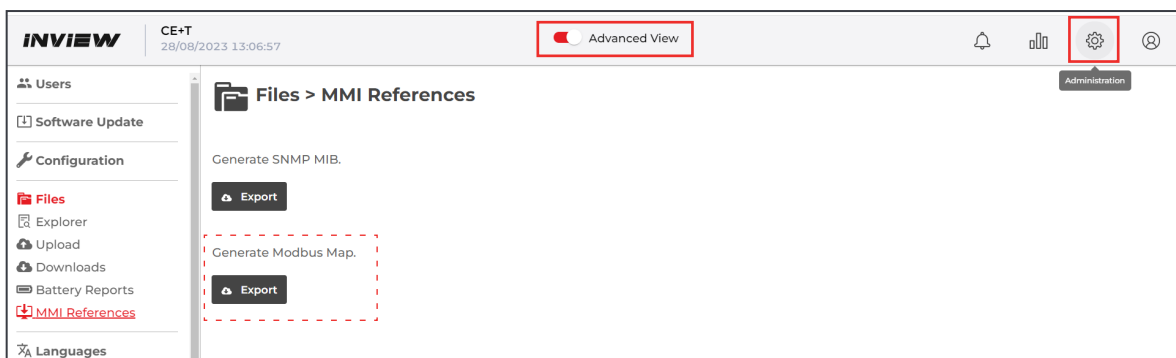

The screenshot shows the Inview web interface. At the top, there is a header with the Inview logo, the text 'CE+T 28/08/2023 13:06:57', and a toggle for 'Advanced View'. On the right side of the header, there are icons for notifications, a bar chart, a gear (Administration), and a user profile. The main content area is titled 'Files > MMI References' and contains two sections: 'Generate SNMP MIB.' with an 'Export' button, and 'Generate Modbus Map.' with an 'Export' button. The 'Generate Modbus Map.' section and its 'Export' button are highlighted with a red dashed box. A sidebar on the left contains navigation options: Users, Software Update, Configuration, Files, Explorer, Upload, Downloads, Battery Reports, and Languages.

### 7.10.2 SNMP

This section describes the Management Information Base (MIB) schema design for SNMP V1, V2c and V3 configuration. A MIB schema describes the structure of information served by a Simple Network Management Protocol Subsystem (SNMP) agent.

For the SNMP configuration, go to [Advanced View](#) > [Site](#) > [Configuration](#), scroll down to the *SNMP Agent* section and select the following options.

- In the ID CF61, select “True” to enable the SNMP function and enter the port address in the ID CF62.
- In the ID CF63, select the SNMP version V1, V2C or V3.

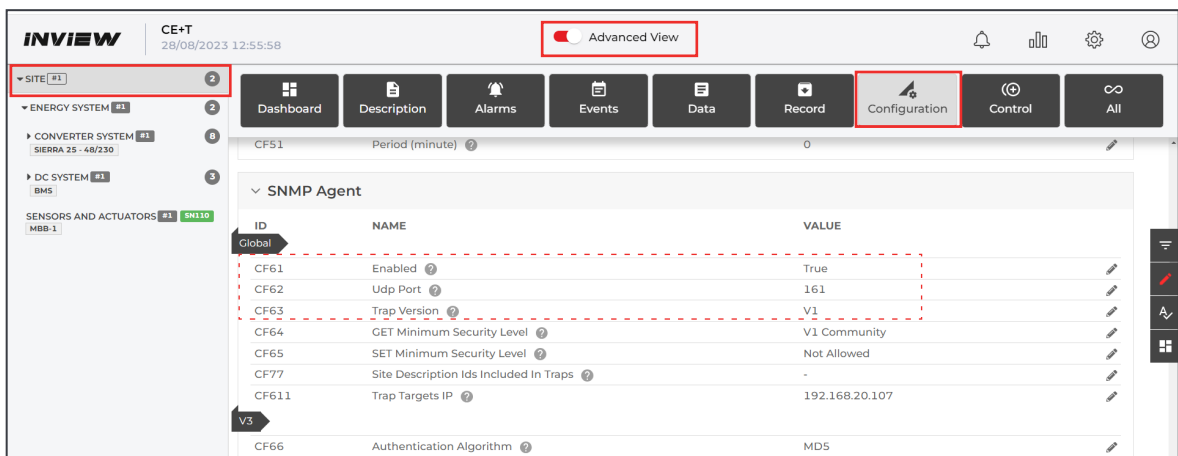

ID	NAME	VALUE
Global		
CF61	Enabled	True
CF62	Udp Port	161
CF63	Trap Version	V1
CF64	GET Minimum Security Level	V1 Community
CF65	SET Minimum Security Level	Not Allowed
CF77	Site Description Ids Included In Traps	-
CF611	Trap Targets IP	192.168.20.107
V3		
CF66	Authentication Algorithm	MD5

### 7.10.3 MIB

The MIB file describes the specific format of data provided by the SNMP agent running within the subsystem. The data is grouped in terms of high-level objects and therefore models a top-down hierarchical design.

To download the SNMP MIB file, go to [Administration](#) > [Files](#) > [MMI References](#) and click *SNMP MIB* “Export” button.

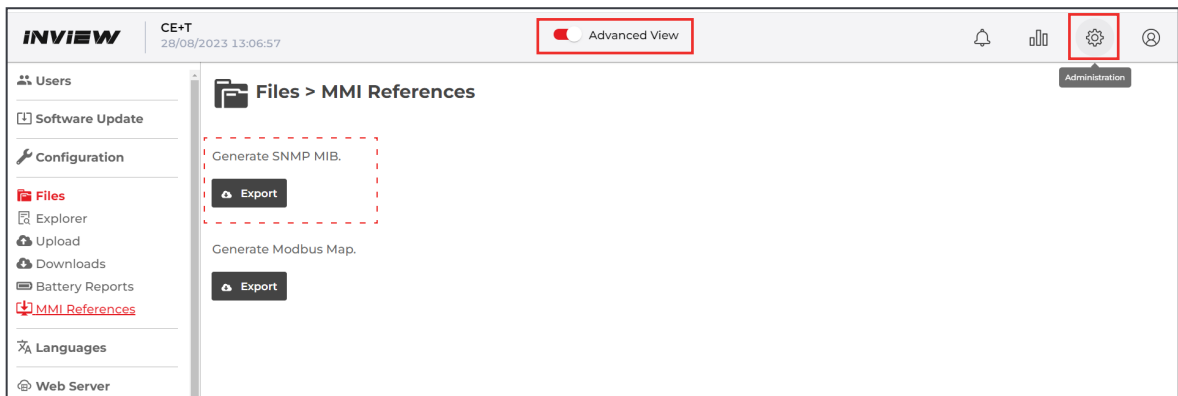

## 7.11 Cyber Security

### 7.11.1 Password Policy

Starting from Inview software version 5.5, a new password policy is introduced. The password must be a minimum of eight characters.

If the wrong password is entered continuously five times, next time, the Inview restrict to login, and it will allow again only after five minutes.

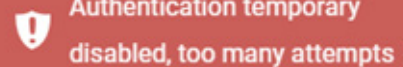

### 7.11.2 Weak Password Alarm

An alarm is raised when the system detects any user using a legacy password storage, default password or default pin code.



To fix the weak password alarm, check the followings:

- Ensure the PIN code is not having the default value.
- Ensure that no user is using the default password.
- If the configuration is migrated from an older version, use the web interface and change the existing password.

### 7.11.3 Password Protection

In Inview software version 5.5, a new password protection feature is added. To know more about it and configure it, go to [Advanced View > Site > Configuration > Webserver section > CF33 \(Enable password recovery\)](#).

- If “True” is selected, the web interface passwords and PIN details will be present while exporting the configuration and log files. *(Note: the password details are encrypted)*
- If “False” is selected, the password (for users, SNMP, Mail, MQTT, etc.) and PIN details are protected and will not be available in the configuration and log files.

### 7.11.4 Software Downgrade and Reset

To know about software downgrade and factory reset, go to [Advanced View > Site > Configuration > Controller section > CF152 and CF153](#). By default, the “True” option will be present on both parameters.

Maintenance		
CF152	Allow technical downgrade process	True
CF153	Allow technical Factory reset process	True

**Warning:** If both CF152 and 153 parameters are in False condition and the controller is corrupted, there is no possibility of recovering the data and cannot do the factory reset.

- **CF152 (Allow technical downgrade process):** Select the “True” option and downgrade the software version to the previous one using the USB key. Contact CE+T for the downgrading process.
- **CF153 (Allow technical Factory reset process):** Select the “True” option and perform the factory reset using USB Key. After the factory reset, the controller will be in default settings. Contact CE+T for the factory reset process.



## 8. Overview - LCD Interface

### 8.1 Inview Slot - LCD Display

Once the system is powered up, the Inview Slot is up and ready for operation. The LCD is a 1.8-inch touch screen and user can only view the system details through the interface.

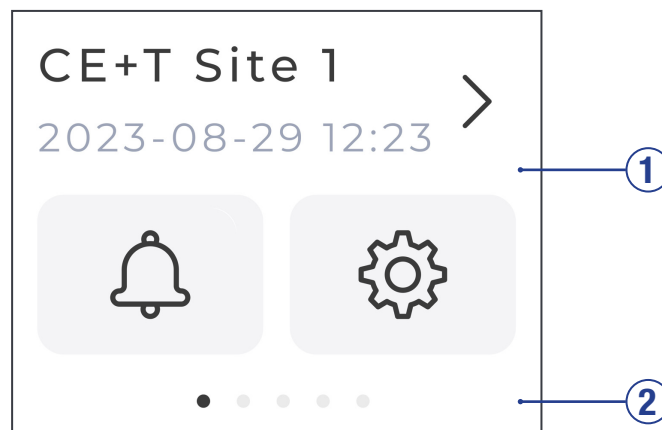

- **[1] Interface area:** The interface area provides information about the corresponding page.
  - Displays the Site place, Date and Time.
  - The notification icon to view Alarms and Events and the settings icon provides access to other action screens.
  - Navigation arrows to the next screen or swipe left and right. Up and down arrows appear on some screens, indicating more information is present.
- **[2] Status bar**

The status bar appears throughout the interface and indicates the screen sequence.

#### 8.1.1 LED Indications

Three LED's are present behind the front black plastic of the controller to indicate major alarm, minor alarm, and system status. These LED's are not visible until they illuminate during the corresponding action occurs.

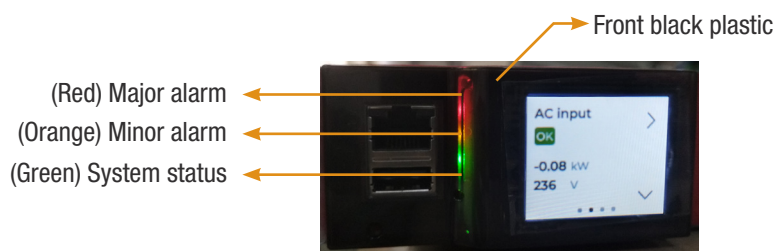

### 8.1.2 Menu Structure

The home page is the default page in the LCD interface, and other pages are arranged in the below sequence.

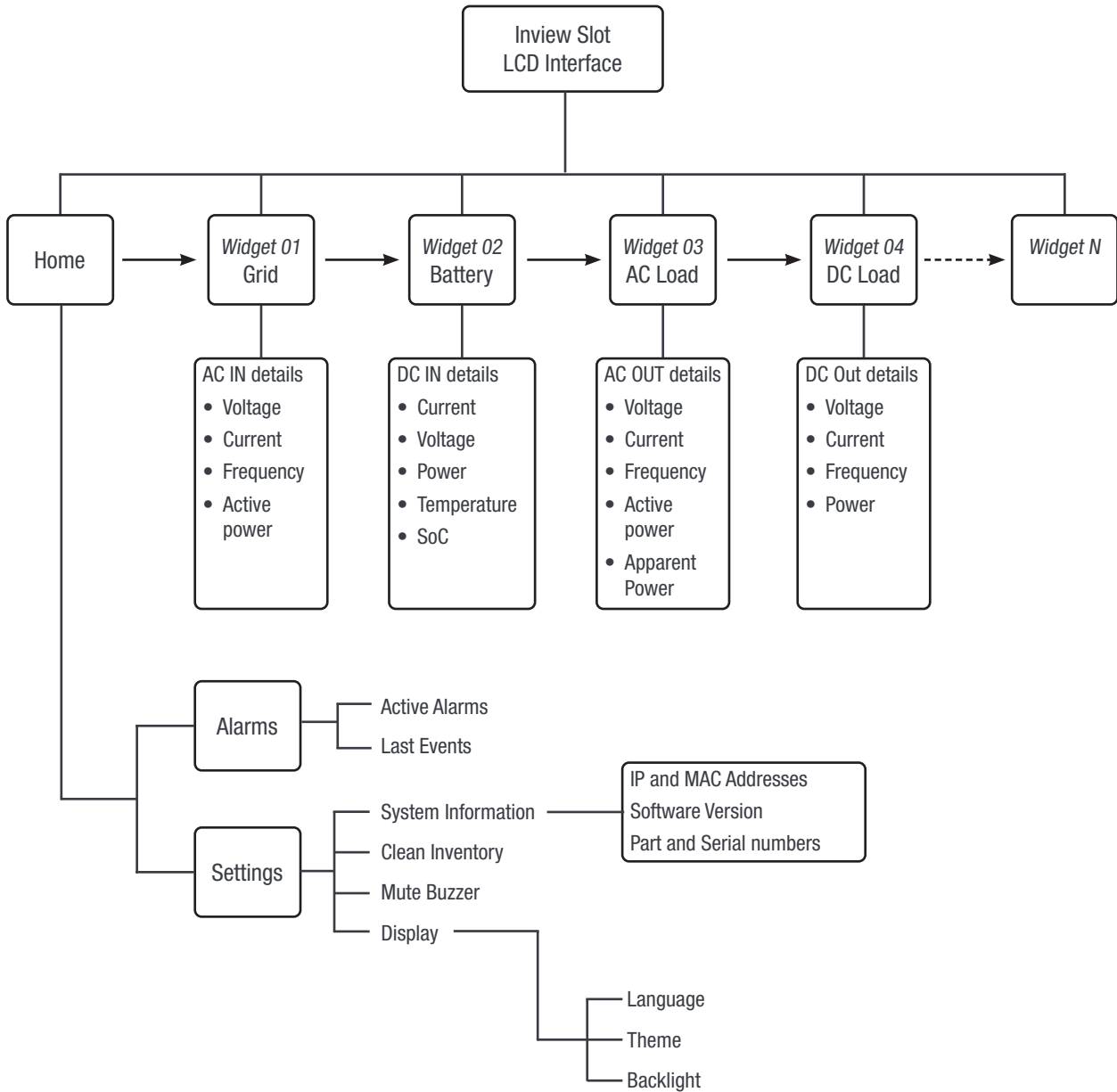



## 8.2 Inview S - LCD Interface

Inview S LCD interface is a 2.8-inch touch screen. It does not have any user account, the user can only view the system details. The LCD interface is protected with the PIN during any action request. To modify the PIN, refer section 7.2.2, page 36.

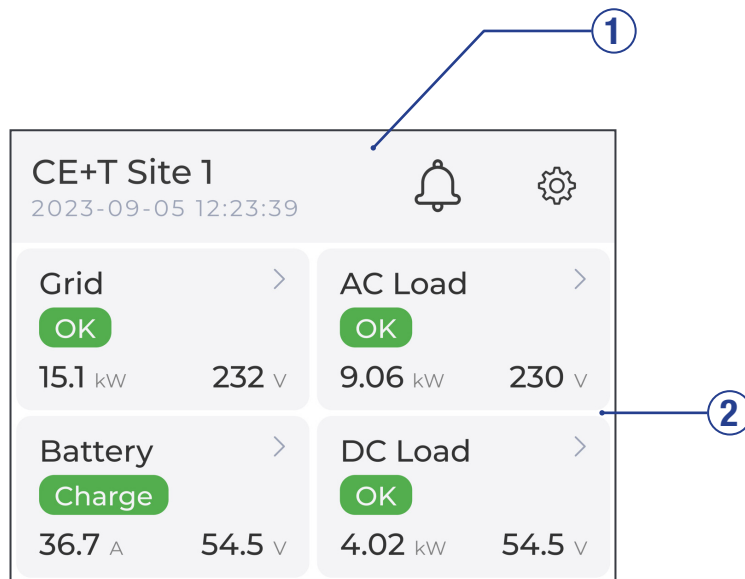
Once system is powered upon, the Inview S is up and ready for operation.



- **[1] Header:** Displays the Site name, Date and Time.
  - **Events:** Tapping on  goes to Alarms and Events screen.
  - **Administration:** Tapping on  provide access to different action screens.
- **[2] Interface Area:** Tapping on the widget provides the corresponding parameter information. Provides information about the corresponding screen. In some screens, left and right navigation buttons appear, indicating more screens are present.
- **Navigation arrows** for the next and previous pages. Up and down arrows appear on some screens, indicating more information is present.

### 8.2.1 LED Indications

Three LED's are present at front side of the controller to indicate major alarm, minor alarm, and system status.

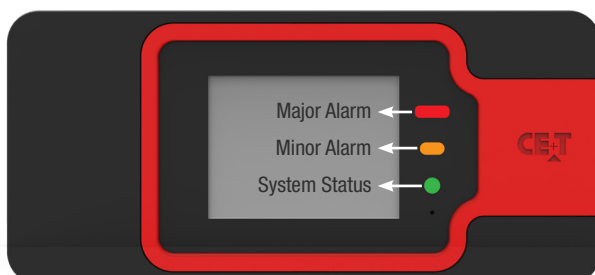

### 8.2.2 Menu Structure

The below tree provides an overview of the menu structure in the Inview S LCD interface.

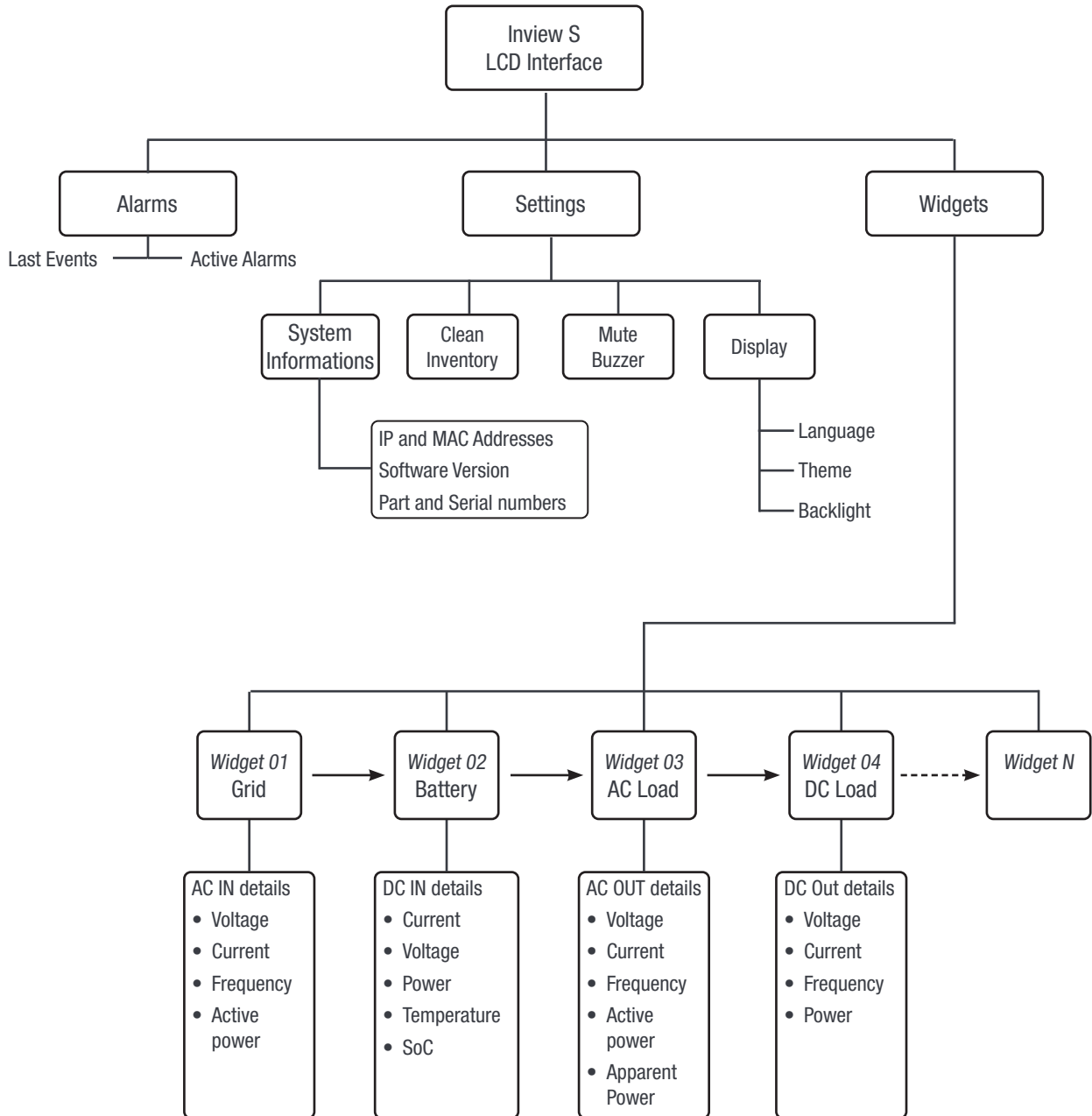



### 8.3 Inview X - LCD Interface

Inview X LCD interface is a 7-inch touch screen. Through the LCD interface, the user can view and access the system details. Once the system is powered upon, the Inview X is up and ready for operation.

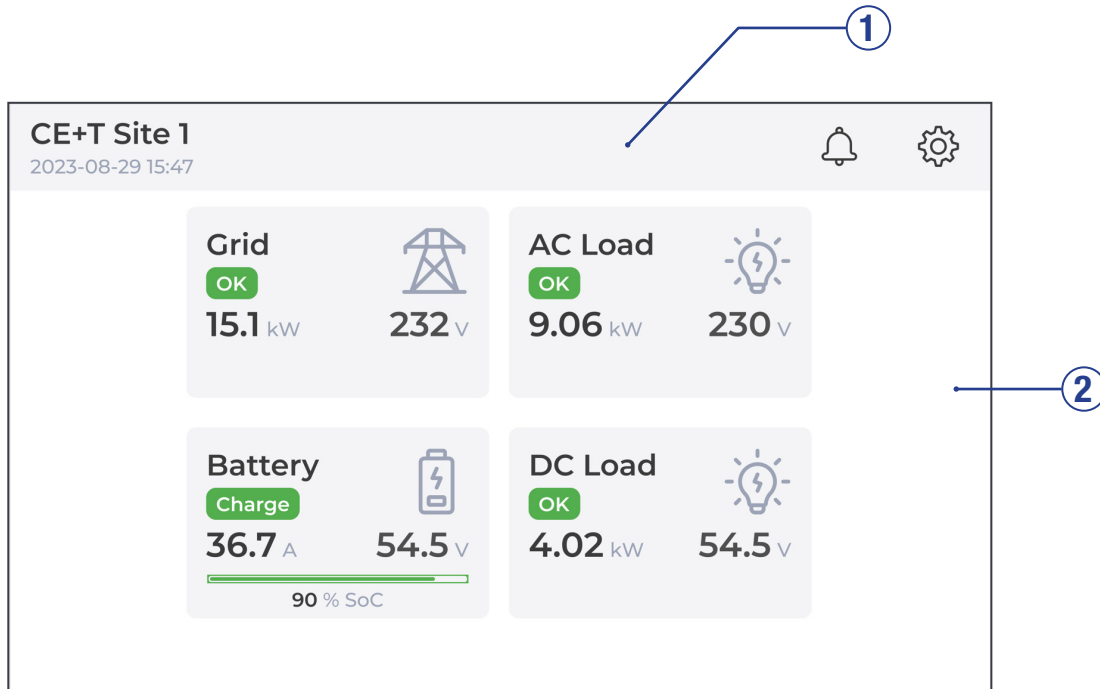
Note: Interface graphics and layout may change based on firmware version.



- **[1] Header:** Displays the Site name, Date and Time.
  - **Events:** Tapping on  goes to Alarms and Events screen.
  - **Administration:** Tapping on  provide access to different action screens.
- **[2] Interface Area:** Tapping on the widget provides the corresponding parameter information. Provides information about the corresponding screen. In some screens, left and right navigation buttons appear, indicating more screens are present.
- **Navigation arrows** for the next and previous pages. Up and down arrows appear on some screens, indicating more information is present.

### 8.3.1 Menu Structure

The below tree provides an overview of the menu structure in the Inview X LCD interface.

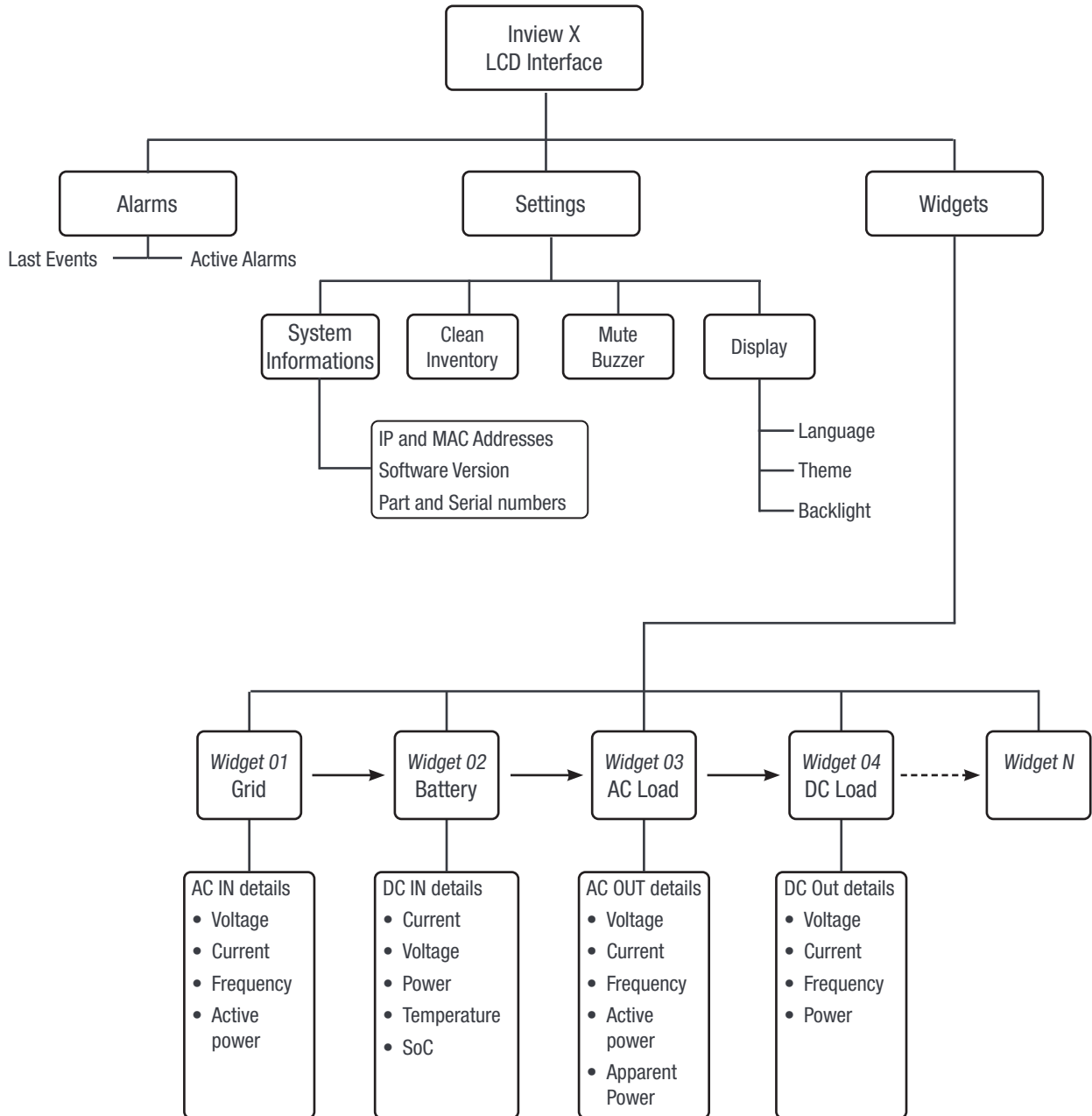

### 8.3.2 LED Indications

Three LED's are present behind the front white plastic of the controller to indicate major alarm, minor alarm, and system status. These LED's are not visible until they illuminate during the corresponding action occurs.

Light Blue: Normal Operation

Orange: Minor Alarm

Red: Major Alarm

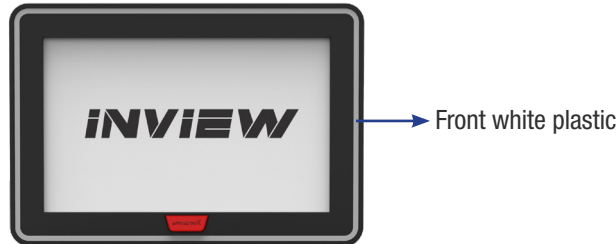

### 8.4 Inview XC - LED Indications

Three LED's are present at top side of the controller to indicate major alarm, minor alarm, and system status.



Red: Major Alarm

Orange: Minor Alarm

Green: System status (Normal Operation)

### 8.5 LCD interface - Terminology

The below table provides the description of terminology which appears in Inview Slot, S and X LCD interface.

S.NO	Terminology	Description
1	Clean Inventory	The controller performs a complete scan and remove the non-active converters from the converter list. <i>Note: If any parameter is changed, an authentication page appears. Enter the display PIN password to apply changes. To modify the password, refer to section 7.2.2, page 36.</i>
2	Mute buzzer	Buzzer sound will be muted
3	Logs	Display the latest 100 events occurred.
4	System Information	Displays product, network and software details

## 9. Defective Unit

### 9.1 Return Defective Inview

- A repair request should follow the regular logistics chain:  
End-user => Distributor => CE+T Power.
- Before returning a defective product, a RMA number must be requested through the <http://my.cet-power.com> extranet. Repair registering guidelines may be requested by email at [repair@cet.be](mailto:repair@cet.be)
- **Freight costs:**
  - The cost to ship the unit(s) from the Customer's premises back to CE+T Power is at the Customer's charge.
  - CE+T Power will pay for the shipping of the unit(s) back to the Customer's premises.
- **Warranty:**
  - The warranty will be void if the transport conditions or packing were inadequate.
  - The warranty will be cancelled if the unit sent for repair has been opened by parties other than a CE+T approved Repair Centre.
- **Repair costs:**
  - If the faulty unit is under warranty, CE+T Power will bear the repair costs.
  - If the warranty is void, the repair costs will be invoiced to the Customer.
  - If a unit sent back to CE+T Power (Repair or Swap) presents no defect or failure, a lump sum amount will be charged to the Customer.
- **Swap conditions:**
  - You must provide CE+T Power with a Purchase Order for the new unit that you are requesting, at the current price. No Swap request will be accepted without it!
  - Within 3 months of the reception of our Swap approval email, you will have to provide CE+T Power with a tracking reference proving that you have shipped the faulty unit(s) back to CE+T Power.
  - If CE+T Power does not receive the tracking reference or the unit in time, CE+T Power will automatically invoice the unit(s) sent in exchange, at the current price list value.
- **RMA:**
  - Your Return Material Authorization number (RMA) and the address of the appropriate Repair Centre will be confirmed to you after careful review of your request.
  - The RMA number must be present on the packing and all the paperwork of the returned material.
  - So PLEASE, wait until you receive these two informations before you ship us the faulty unit.



# 10. Trouble shooting and Service

## For Service

- Check Service Level Agreement (SLA) of your vendor. Most of the time they provide assistance on call with integrated service. If such SLA is in place, you must call their assistance first.
- If your vendor doesn't provide such assistance (\*) you may contact CE+T through email.
  - USA and Canada: [tech.support@cetamerica.com](mailto:tech.support@cetamerica.com)
  - Rest of the world: [customer.support@cet-power.com](mailto:customer.support@cet-power.com)

Before sending the unit to repair, download the debug file and send it to CE+T customer support team through email.

Perform the following steps to download and send the file:

1. Go to **Administration > Support** and click **"Download support package"** to download the "diagnostics" zip file.

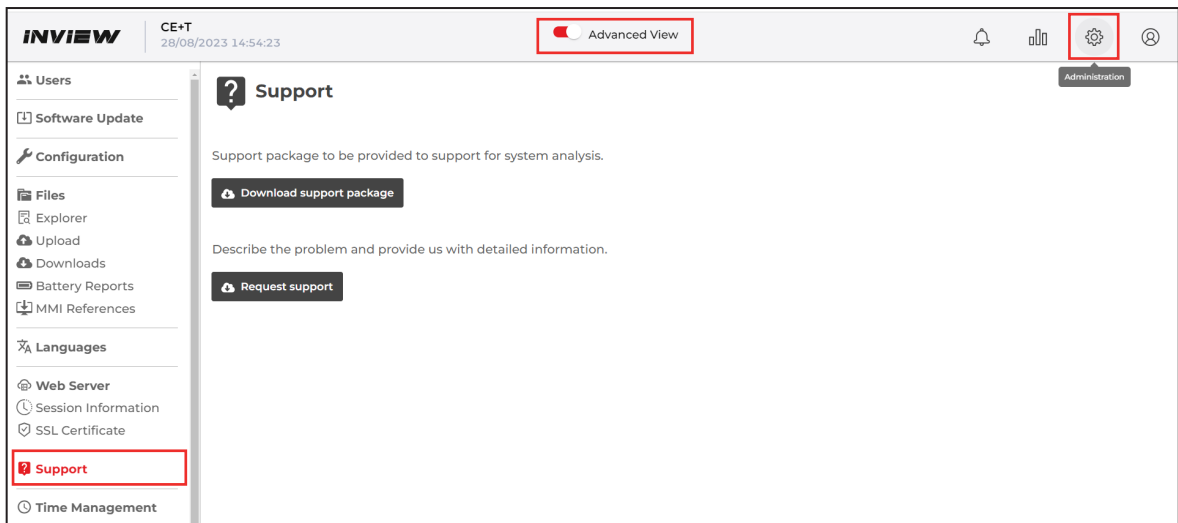

2. To send the diagnostic file to CE+T customer support, Click **"Request support"**, a new email will pop up from your default outlook with the CE+T address, subject and body text as below.

3. Attach the diagnostic file in the email and sent it.

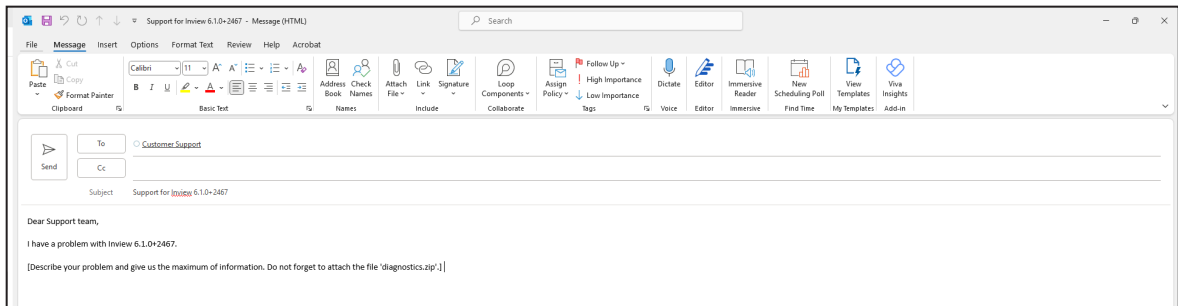

# 11. Annexe 1: Converter - Parameter List

To view and edit the converter parameters, go to *Advanced View > Site > Energy System > Converter System > Configuration*.

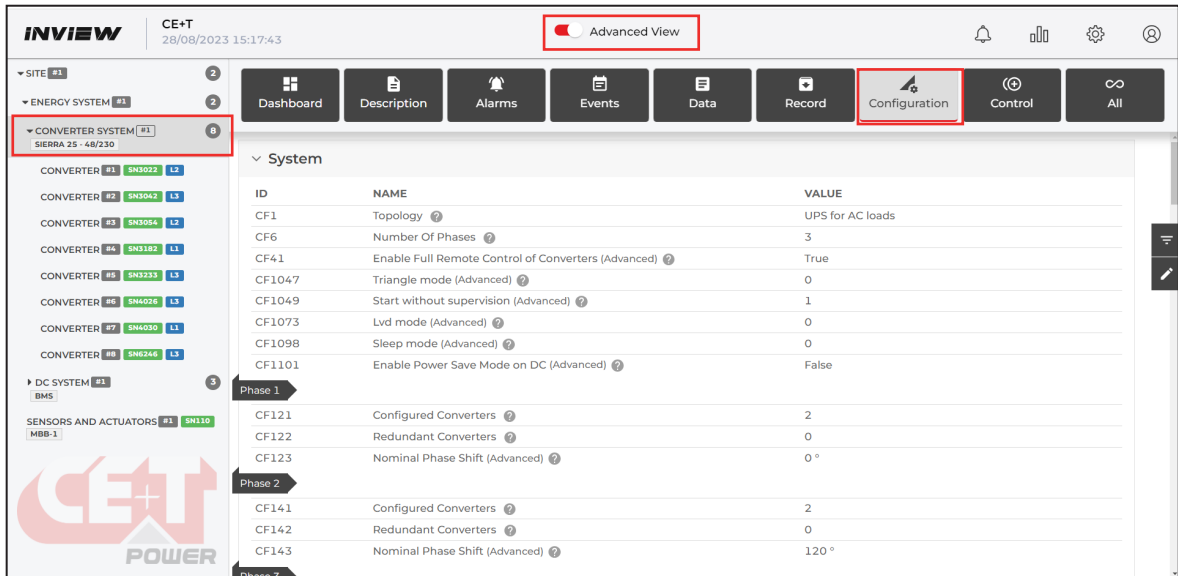

The screenshot shows the Inview software interface. The top navigation bar includes 'Advanced View' (highlighted with a red box). The left sidebar shows a tree view with 'CONVERTER SYSTEM #1' selected (highlighted with a red box). The main content area displays a table of system parameters under the 'System' section.

ID	NAME	VALUE
CF1	Topology	UPS for AC loads
CF6	Number Of Phases	3
CF41	Enable Full Remote Control of Converters (Advanced)	True
CF1047	Triangle mode (Advanced)	0
CF1049	Start without supervision (Advanced)	1
CF1073	Lvd mode (Advanced)	0
CF1098	Sleep mode (Advanced)	0
CF1101	Enable Power Save Mode on DC (Advanced)	False
Phase 1		
CF121	Configured Converters	2
CF122	Redundant Converters	0
CF123	Nominal Phase Shift (Advanced)	0°
Phase 2		
CF141	Configured Converters	2
CF142	Redundant Converters	0
CF143	Nominal Phase Shift (Advanced)	120°

If you want to have an overview of standard systems' parameters, you can also view the parameters in our Monitoring Emulator <https://www.cet-power.com/en/monitoring-emulator/>. Do not hesitate to use the help buttons for more information about the parameters.

## 12. Annex 2: Boolean Expression Functionalities

### 12.1 Overview

Boolean expressions can be used to open/close relays under user defined logics for their requirements and for specific alarm monitoring.

#### 12.1.1 Our Boolean Expression Syntax

Abbreviations	Descriptions
invsX	States inverter system with ID X
convsX	States converter system with ID X
dcdcX	States DC converter system with ID X
rdcsx	States remote DC system with ID X
coX	States Converter with ID X
dcY	States DC system with ID Y
saX	States Sensors and actuators with ID X

#### 1. Operators & functions

Syntax	Explanation
(...)	Parentheses
&&	Logical AND
	Logical OR
==	Equal
!=	Not Equal
+	Addition
-	Subtraction
*	Multiplication
/	Division
>	Superior
>=	Superior or Equal
<	Inferior
<=	Inferior or equal
\$minute()	Minute part of the actual time
\$hour()	Hour part of the actual time
\$day()	Integer indicating the day of the month
\$dayofweek()	Integer indicating the day of the week. This integer ranges from zero =>indicating Sunday, to six=> indicating Saturday
\$dayofyear()	Integer indicating the day of the year
\$month()	Integer indicating the month of the year

Syntax	Explanation
\$year()	Integer indicating the year
\$time()	The actual time of the day
@ts(XXXXX)	Create a timespan variable from XXXX string. Example: @ts(11:30) corresponds to 11h:30.
\$iif(condition, val if true, val if false)	Equivalent to “If then else”

### 2. Using data and alarm entries from a monitored device

Syntax	Explanation
@(dataXXX) , @(daXXX)	The data with id XXX of the relative equipment Example: @(data501), @(da501)
@(dcY_dataXXX)	The data with id XXX relative to the dc system with id Y. Example: @(dc1_data60)- Denotes voltage data with id data60 from dc system 1
@(saY_dataXXX)	The data with id XXX relative to the Sensors And Actuators with id Y. Example:@(sa1_data101) – Denotes voltage measured with data id 101 from Sensors and actuators with ID 1
@(alarmXXX) , @(alXXX)	The alarm with id XXX of the relative equipment Example: @(alarm501), @(al501) – Denotes Alarm ID 501.
@(convsY_alXXX)	The alarm with id XXX of the relative equipment Example: @(convs1_al103) – Denotes Alarm ID 103 from converter system 1.
@(dcY_alarmXXX)	The data with id XXX relative to the dc system with id Y. Example: @(dc1_data202) is the bus voltage with data ID202 of the DC System 1.
@(saY_alarmXXX)	The data with id XXX relative to the Sensors And Actuators with id Y. Example: @(sa1_alarm501) – Denotes alarm with ID 501 from Sensors and actuators with ID 1

### 12.1.2 Examples of Basics Expressions

Condition or Data	Configuration examples
The bus voltage is under 47V.	@(data11)<47
If the specific inverter output power is over 2500W	@(convs1_co1_data13)>2500
The time of the day is comprised between 10:30 and 11:30	(\$time())>@ts(10:30))&&(\$time())<@ts(11:30))
The day of the week is Sunday	\$dayofweek()==0
The alarm with id 17 is active	@(alarm17) ==True
The alarm with id 17 and 18 are active	@(alarm17) ==True && @(alarm18) ==True
Linking Digital input with relay	<ul style="list-style-type: none"> <li>If Digital input 3 is closed then relay K3 need to be energized. <ul style="list-style-type: none"> <li>D3 alarm ID from Inview: al511</li> <li>Boolean expression set at relay : @(sa1_al511)</li> </ul> </li> <li>Mode: Custom; Boolean Expression: @(sa1_al511)</li> </ul>

Condition or Data	Configuration examples
Linking Specific alarm with Relay	<ul style="list-style-type: none"> <li>• If Redundancy lost alarm need to be configured with relay               <ul style="list-style-type: none"> <li>▪ Redundancy lost alarm ID from Inview: al103</li> <li>▪ Boolean expression need to be set at relay: @ (convs1_al103)</li> </ul> </li> <li>• Mode: Custom; Boolean Expression: @(convs1_al103)</li> </ul>
For specific data range higher or lower value.	<ul style="list-style-type: none"> <li>• When the battery voltage reaches below 45.00v               <ul style="list-style-type: none"> <li>▪ Battery voltage measurement displayed at: sensors and actuators &gt; Data&gt; da101</li> <li>▪ Boolean expression need to be set at relay: @(sa1_al101)&lt;45.00</li> </ul> </li> <li>• Relay Mode: Custom; Boolean Expression: @(sa1_da101)&lt;45.00</li> </ul>

## 13. Annex 3: Inview - Software Upgrade

The current software version number is present on [User Context > About](#). To know more about software details, go to [Advanced View > Site > Description](#) and scroll down to the Controller section.

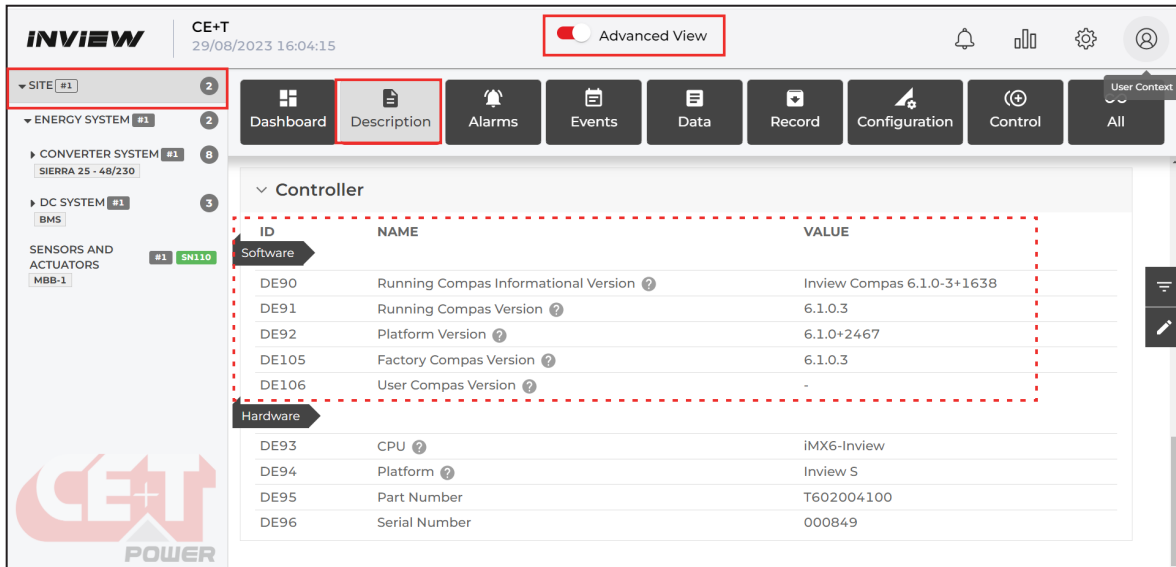

The screenshot shows the Inview web interface. The 'Advanced View' toggle is active. The left sidebar shows a tree view with 'SITE #1' selected. The main content area displays the 'Controller' section with a table of software and hardware details.

ID	NAME	VALUE
<b>Software</b>		
DE90	Running Compas Informational Version	Inview Compas 6.1.0-3+1638
DE91	Running Compas Version	6.1.0.3
DE92	Platform Version	6.1.0+2467
DE105	Factory Compas Version	6.1.0.3
DE106	User Compas Version	-
<b>Hardware</b>		
DE93	CPU	IMX6-Inview
DE94	Platform	Inview S
DE95	Part Number	T602004100
DE96	Serial Number	000849

Perform the following steps to upgrade Inview software, and this process can do only through the web interface.

- Go to [my.cet-power.com](http://my.cet-power.com) > [Documents](#) > [Download SOFT](#) > [2\\_MONITORING](#) (link) and download the latest software from the **5\_INVIEW\_X.0** folder. The downloaded file will be “.RAR”, extract and save it in local as “.UPG” extension.

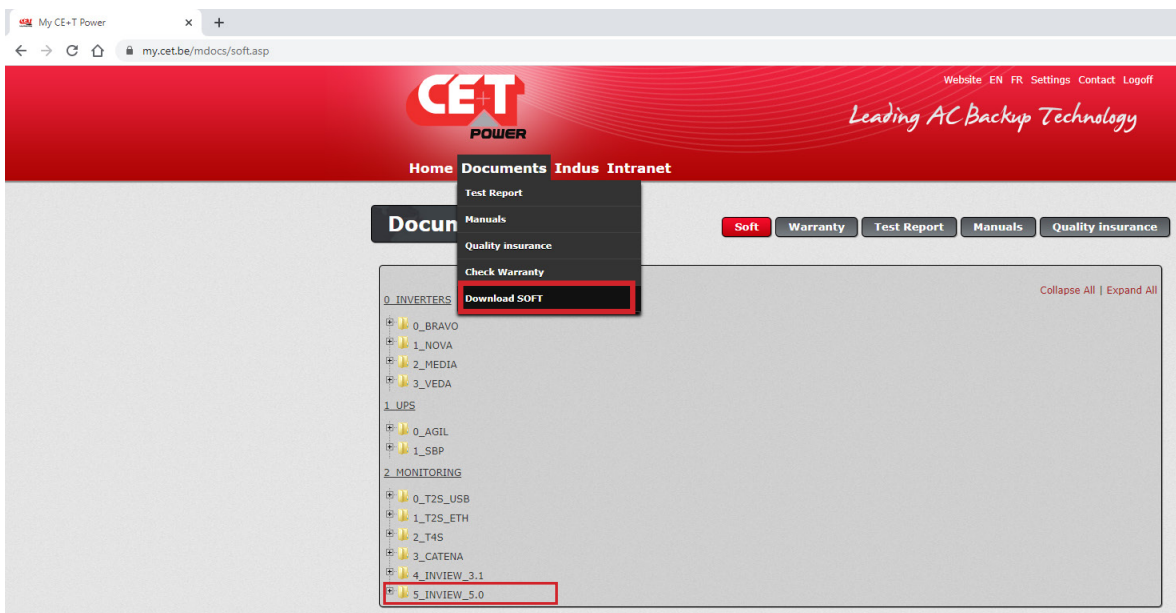

The screenshot shows the website [my.cet.be/mdocs/soft.asp](http://my.cet.be/mdocs/soft.asp). The 'Docu' menu is open, and the 'Download SOFT' option is highlighted. The '5\_INVIEW\_5.0' folder is also highlighted in the file list.

4. Login as admin privileged account in the Inview web interface and go to *Administration > Software Update*.

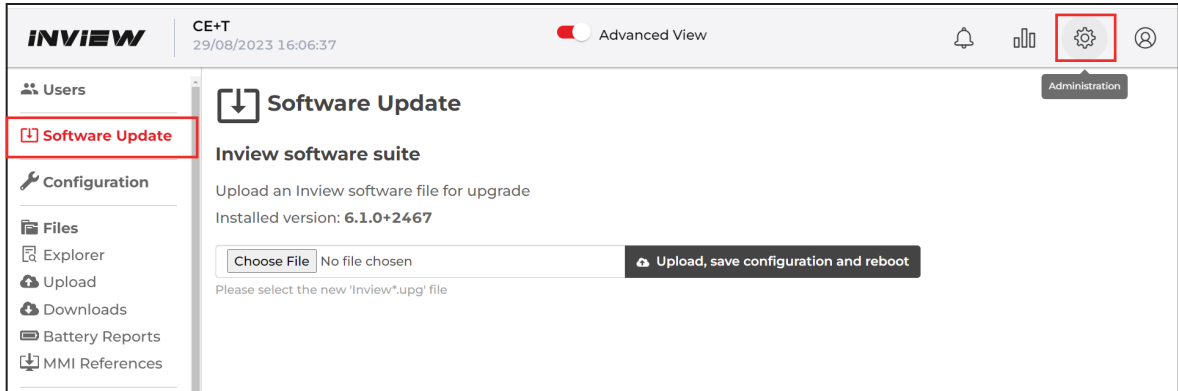

5. Click “Choose file” button and direct to the downloaded .UPG file and the Click “Upload, save configuration and reboot” button.

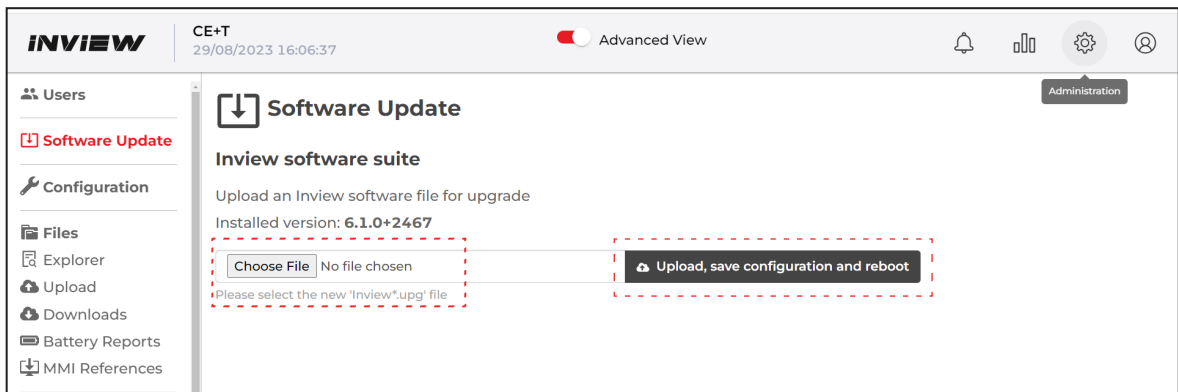

6. Wait, the upgrading process will take approximately 15 minutes to return to normal operating conditions.

7. After successful up-gradation, the web interface resumes to the login screen. Login and verify the Software version below the Inview logo or go to the *Controller* section at *Advanced View > Site > Description* page.

# 14. Annex 4: Hardware replacement

## 14.1 Inview Slot, S, X and XC

Before replacing the new Inview Slot, S, X or XC, the existing configuration file must be saved and need to upload the same after installing the new controller.

**Perform the following steps for replacing Inview Slot, S, X or XC:**

1. Login as admin privileged account, go to *Administration > Configuration*, click “Download configuration file” button, and save the file in local.

*Note: The downloaded file name will be as “configuration.xml” and it should not be renamed.*

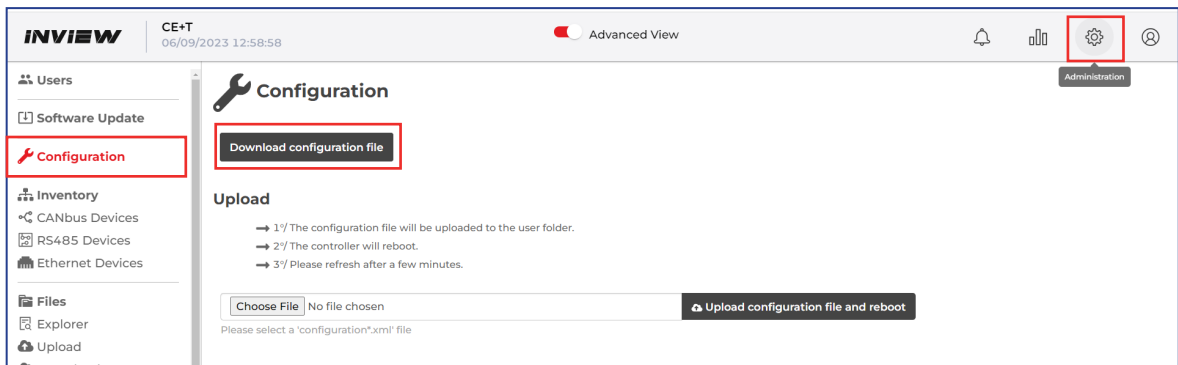

2. Remove the existing controller and install the new controller. To know about installing it and its hardware connections, refer to the section 5, page 17.
3. Power on the controller and login as admin privileged account.
4. Go to *Administration > Configuration*, click “Choose file” button, and direct to the downloaded “configuration.xml” file. Then click “Upload configuration and reboot” button.

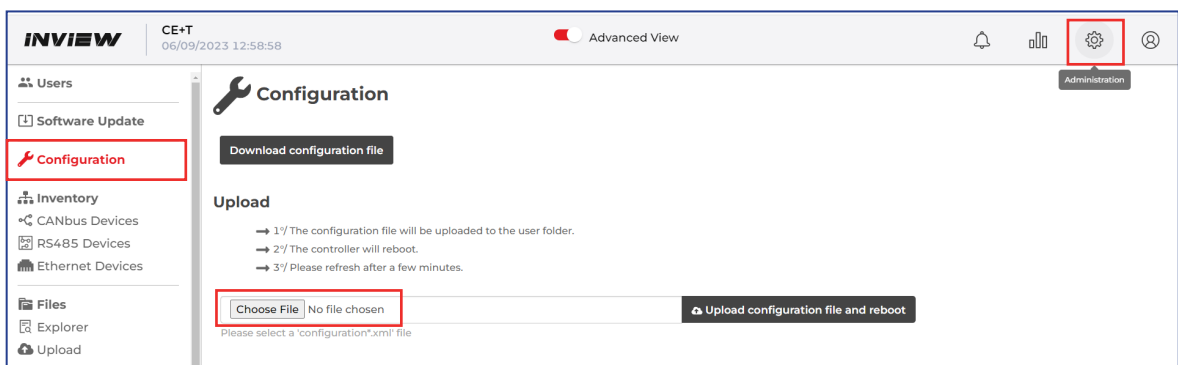



## 14.2 Accessories - MBB and UMB

Perform the following steps for replacing MBB and UMB:

1. Remove the existing MBB/UMB from the system.
2. Clear from the inventory list: go to *Advanced View* > *Site* > *Control*, scroll down to the *Inventory* section. In the ID CT61 (Clean Equipment Inventory), click the  icon to clear it from the list.

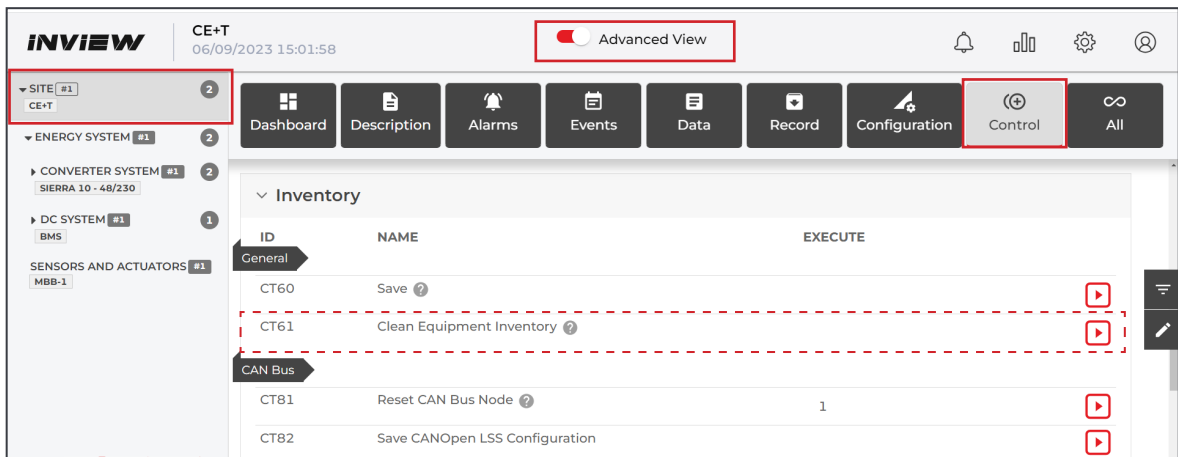

The screenshot shows the INVIEW interface with the 'Control' button highlighted in red. The 'Inventory' section is expanded, showing a table with columns ID, NAME, and EXECUTE. The row for CT61 (Clean Equipment Inventory) is highlighted with a red dashed box, and a red square icon with a white play button is visible next to it.

ID	NAME	EXECUTE
CT60	Save ?	
CT61	Clean Equipment Inventory ?	
<b>CAN Bus</b>		
CT81	Reset CAN Bus Node ?	1
CT82	Save CANOpen LSS Configuration	

3. Connect the new MBB/UMB in the system. To know about the hardware connections, refer to the section 5.6, page 20.
4. To communicate the UMB with the system, go to *Advanced View* > *Site* > *Configuration*, scroll down to *RS485* in the *Inventory* section, and set the following values:
  - ID CF205 (BaudRate) - 19200
  - ID CF206 (Parity) - None
  - ID CF210 (Extension Configuration) - UMB(1,sa1)

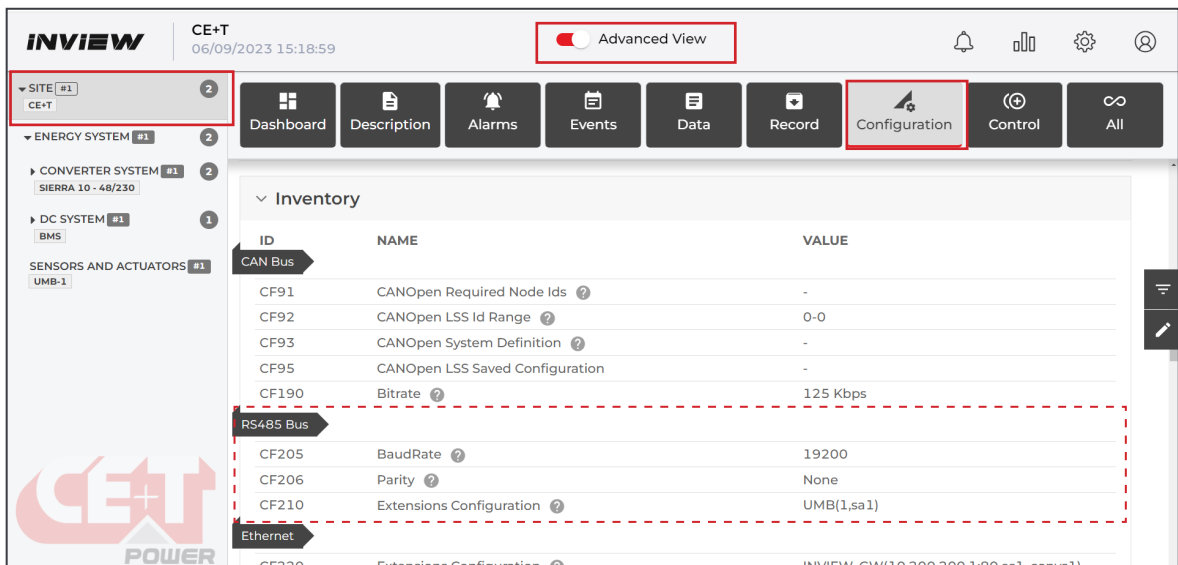

The screenshot shows the INVIEW interface with the 'Configuration' button highlighted in red. The 'Inventory' section is expanded, showing a table with columns ID, NAME, and VALUE. The rows for CF205 (BaudRate: 19200), CF206 (Parity: None), and CF210 (Extensions Configuration: UMB(1,sa1)) are highlighted with a red dashed box.

ID	NAME	VALUE
<b>CAN Bus</b>		
CF91	CANOpen Required Node Ids ?	-
CF92	CANOpen LSS Id Range ?	0-0
CF93	CANOpen System Definition ?	-
CF95	CANOpen LSS Saved Configuration	-
CF190	Bitrate ?	125 Kbps
<b>RS485 Bus</b>		
CF205	BaudRate ?	19200
CF206	Parity ?	None
CF210	Extensions Configuration ?	UMB(1,sa1)
<b>Ethernet</b>		
CF220	Extensions Configuration ?	INVIEW_GW(10.200.200.1:80.es1.conv.s1)

5. Once the MBB/UMB is powered on, make sure it was detected and listed in the "Sensors and Actuators" list.

6. Go to *Advanced View > Sensors and Actuators*, scroll down to *Relay* and *Digital Input* section, and verify the mappings are done correctly.

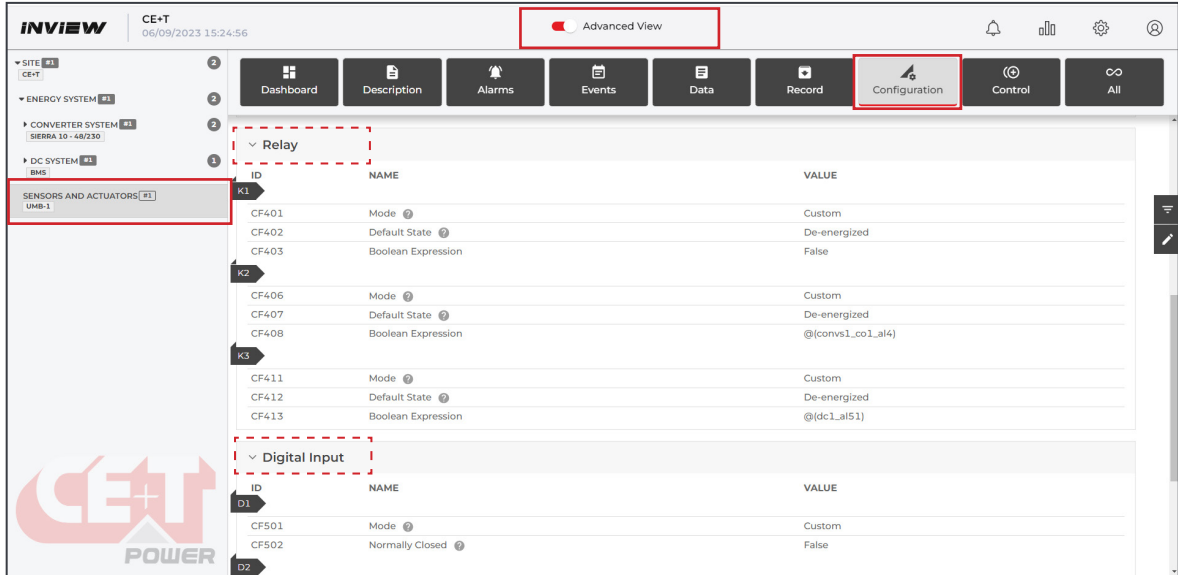

The screenshot shows the Inview software interface for site CE-T. The 'Advanced View' toggle is active. The left sidebar shows a tree view with 'SENSORS AND ACTUATORS' selected. The main content area displays the configuration for 'Relay' and 'Digital Input' sections.

**Relay Configuration Table:**

ID	NAME	VALUE
CF401	Mode	Custom
CF402	Default State	De-energized
CF403	Boolean Expression	False
<b>K2</b>		
CF406	Mode	Custom
CF407	Default State	De-energized
CF408	Boolean Expression	@(convs1_co1_al4)
<b>K3</b>		
CF411	Mode	Custom
CF412	Default State	De-energized
CF413	Boolean Expression	@(dc1_al51)

**Digital Input Configuration Table:**

ID	NAME	VALUE
<b>D1</b>		
CF501	Mode	Custom
CF502	Normally Closed	False
<b>D2</b>		

# 15. Annex 5: Wiring Diagrams

## 15.1 Inview Slot with MBB

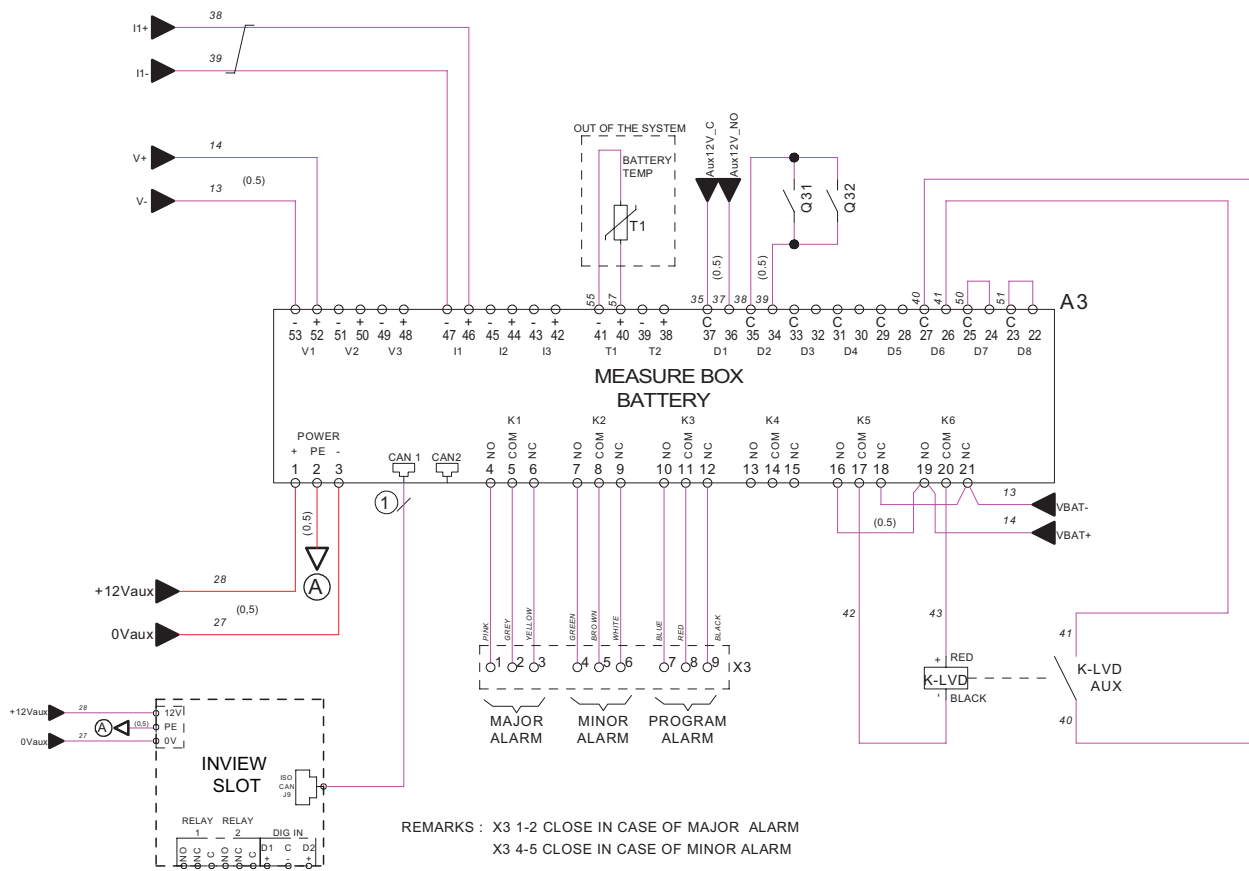

## 15.2 Inview Slot with UMB

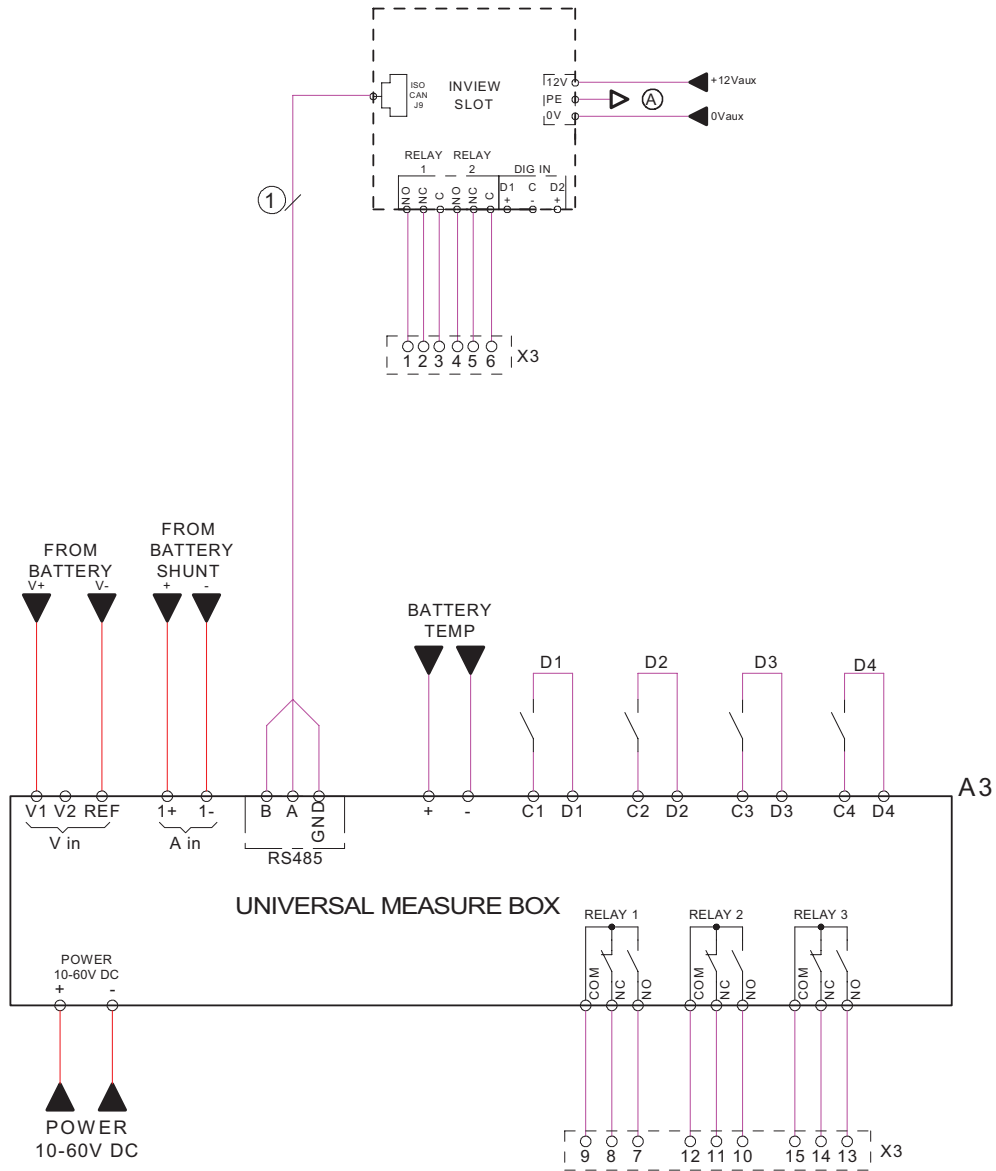

**15.3 Inview S with MBB**

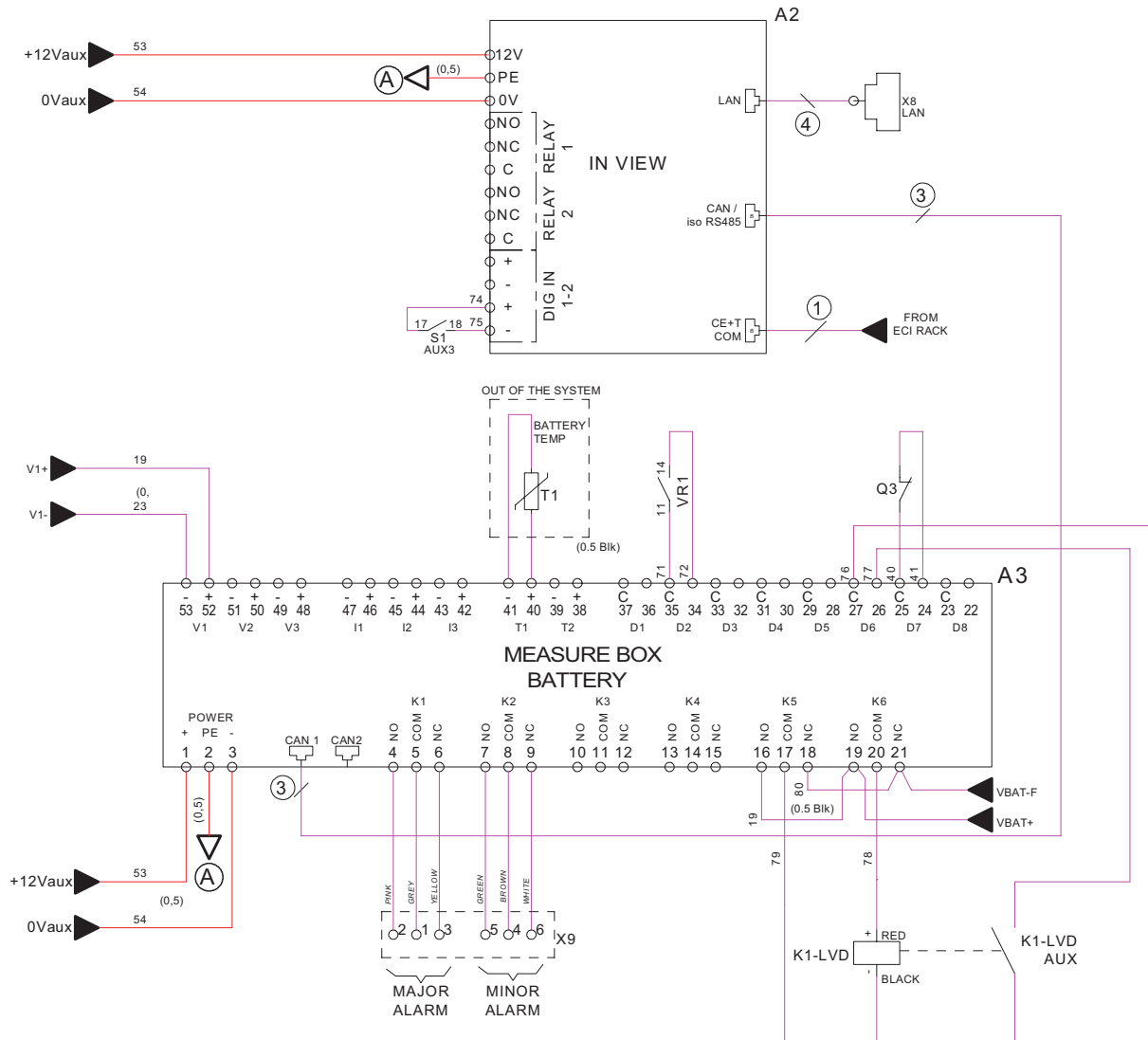

REMARKS : X9 1-2 CLOSE IN CASE OF MAJOR ALARM  
X9 4-5 CLOSE IN CASE OF MINOR ALARM

### 15.4 Inview S with UMB

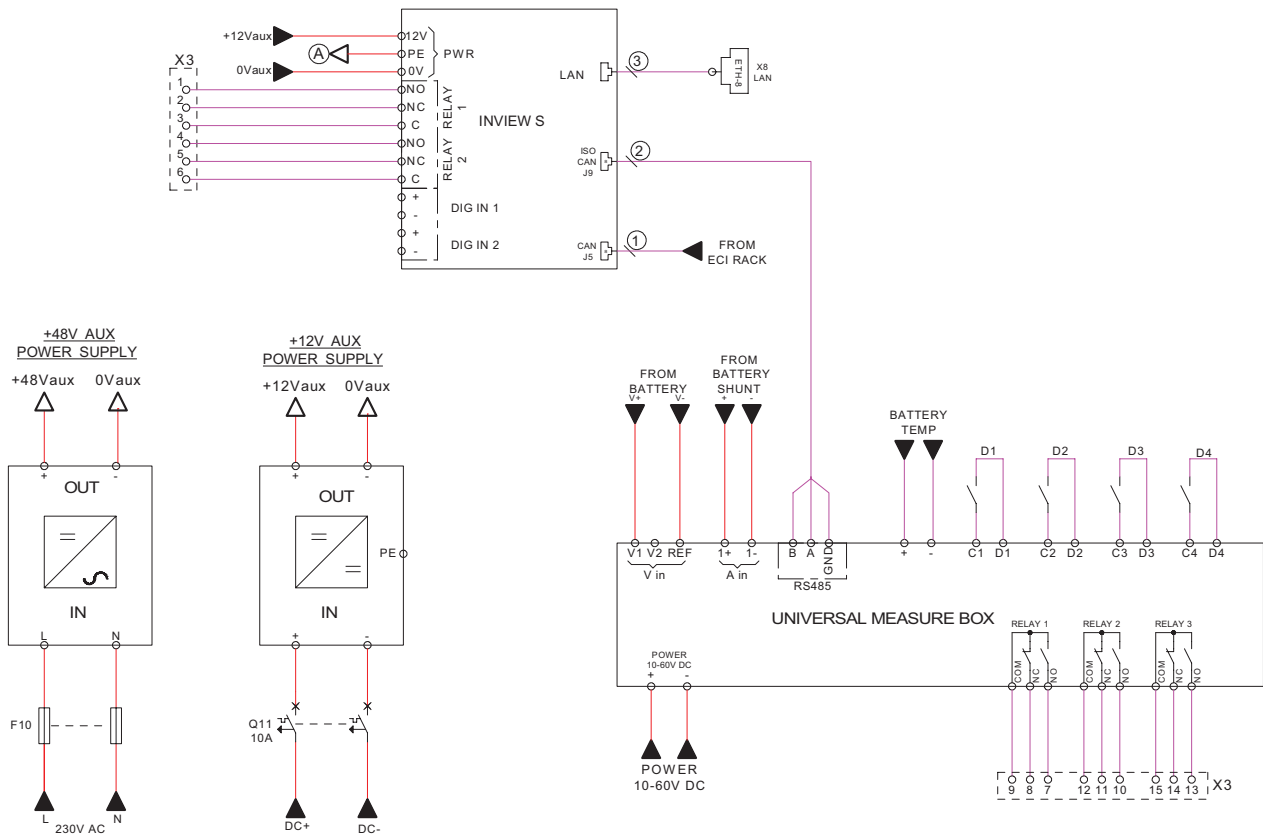

15.5 Inview X with MBB

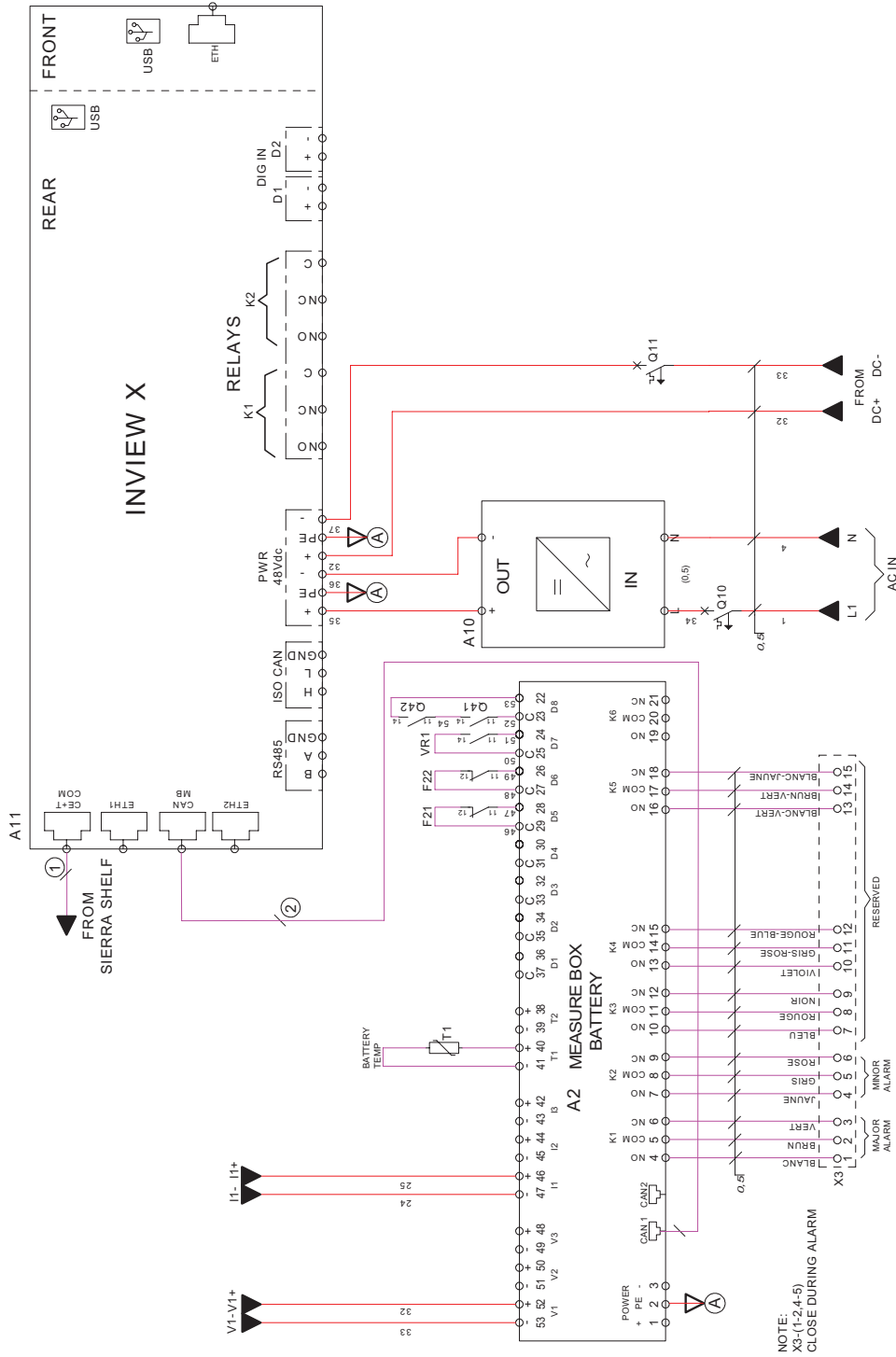

### 15.6 Inview X with UMB

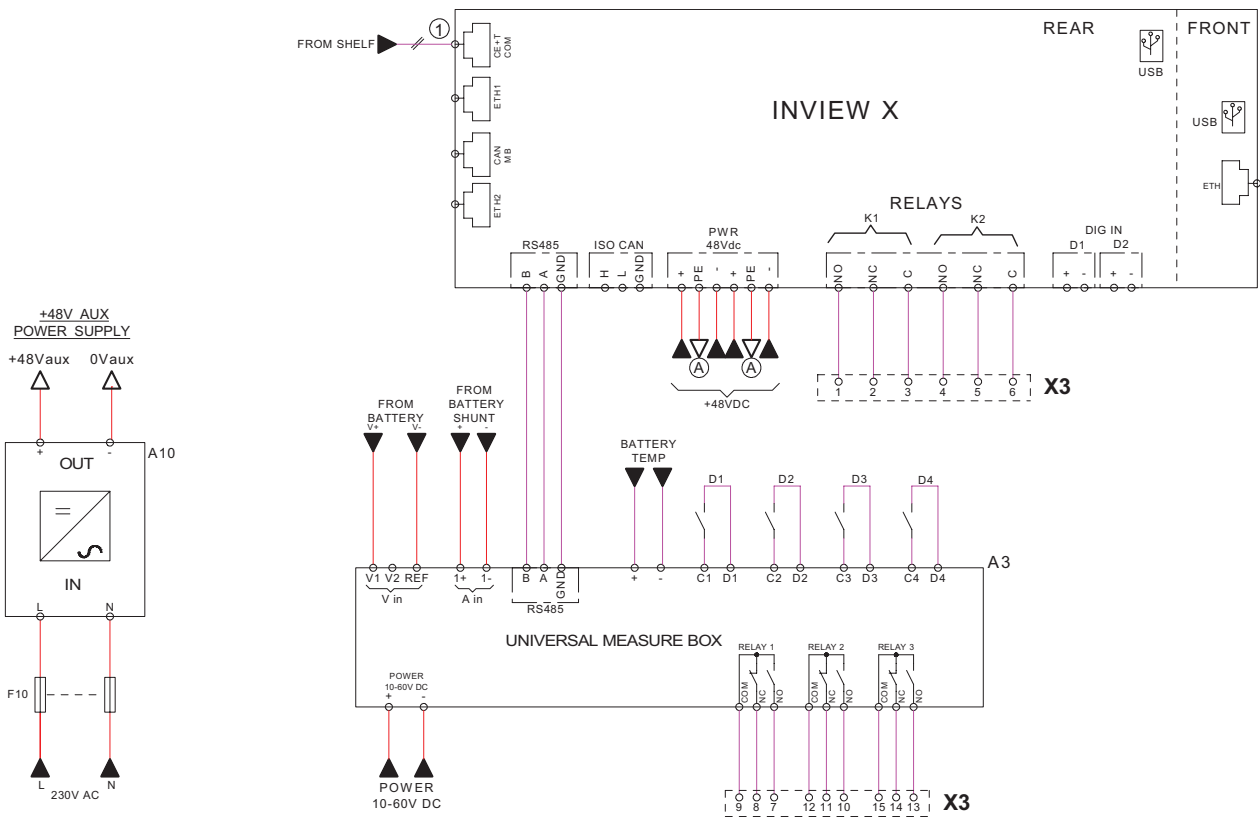



15.7 Inview XC with MBB

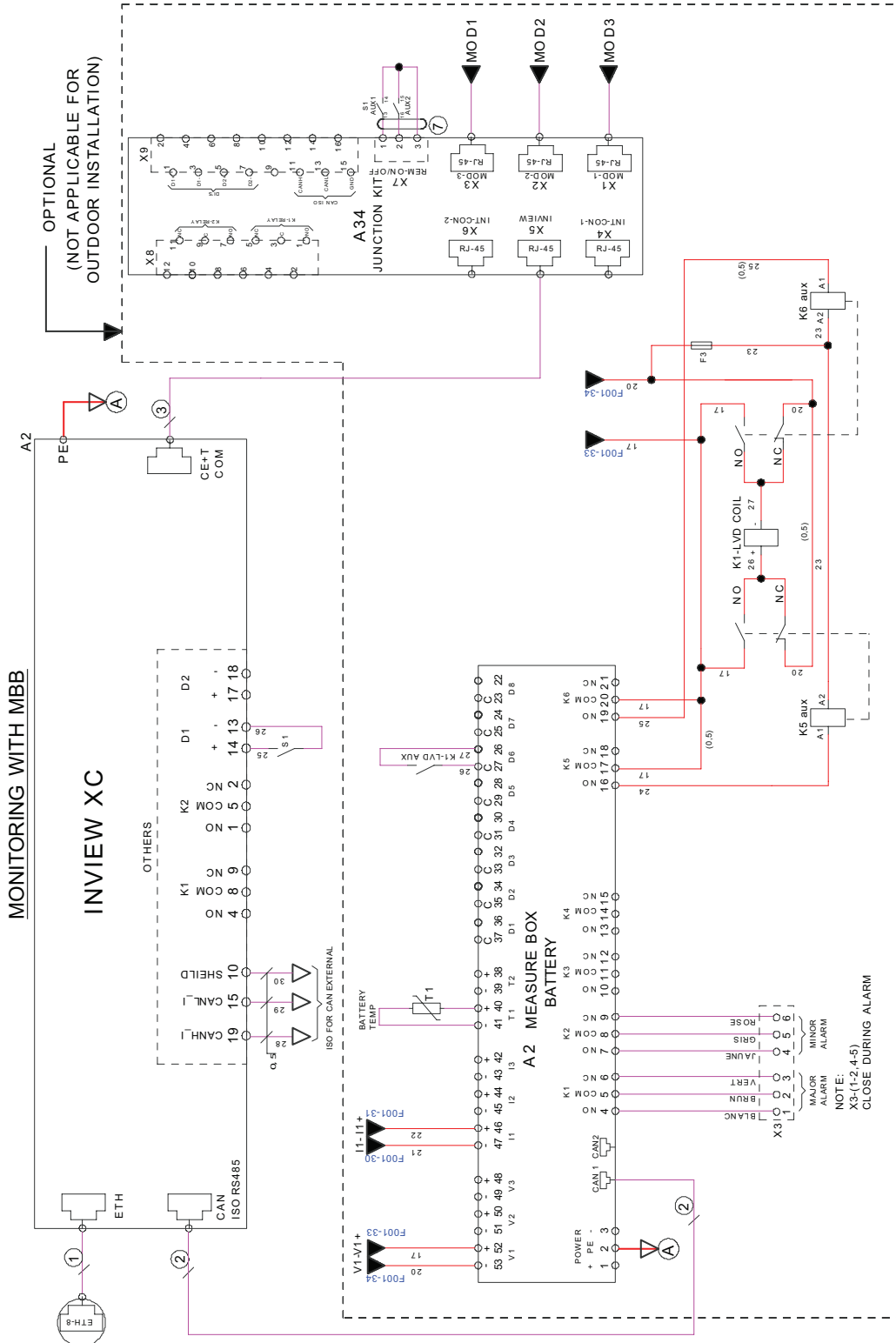

# 16. Annex 6: Auxiliary power supply kit

## 16.1 Auxiliary power supply kit with Din Rail

S.No	Model	Part number
1	48 Vdc	T602004122
2	110 Vdc	T602004124
3	380 Vdc	T602004123

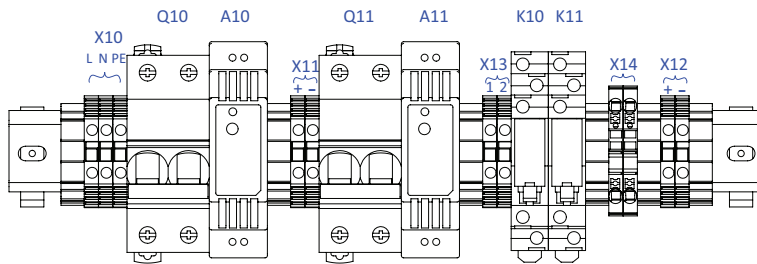

- X10 - AC input terminal (1P)
- X11 - DC input terminal (Battery voltage)
- X12 - DC Output terminal (12 V DC)
- X13 - Alarm contact for Aux power supply unit fail
- X14 - Diodes

Front View

## 16.2 Auxiliary power supply kit - Wiring diagram

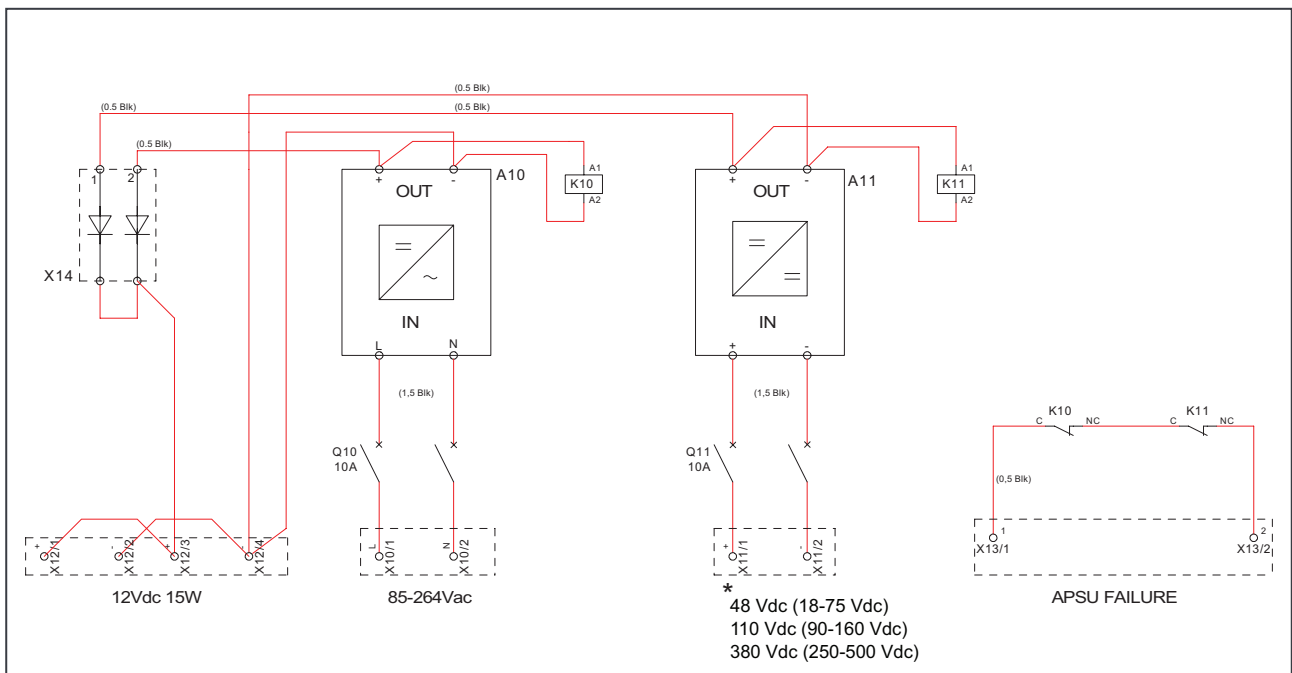

# 17. Annex 7: Inview Panel Sheets

## 17.1 Inview S - Panel Sheets

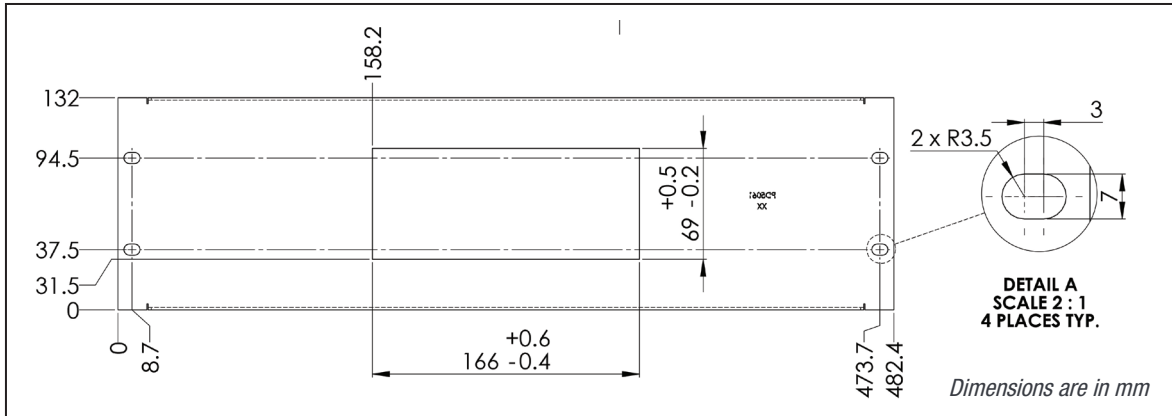

3U Panel sheet - cut out details

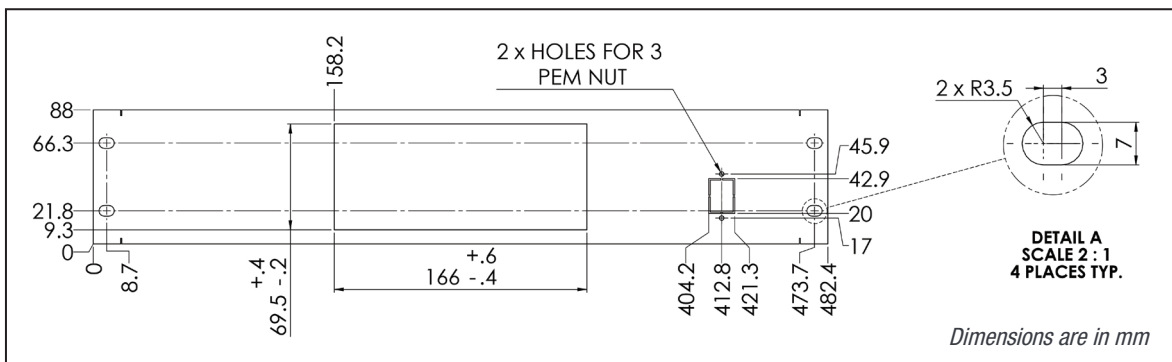

2U Panel sheet (center)- cut out details

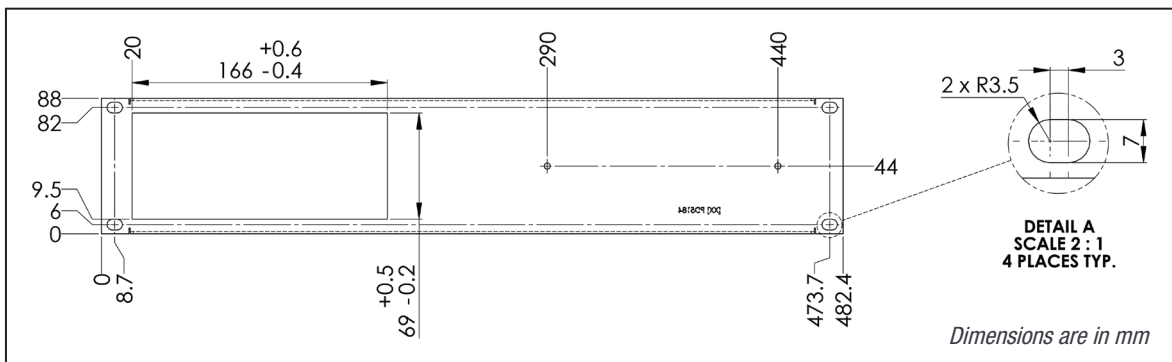

2U Panel sheet (left)- cut out details

### 17.2 Inview X - Panel Sheet

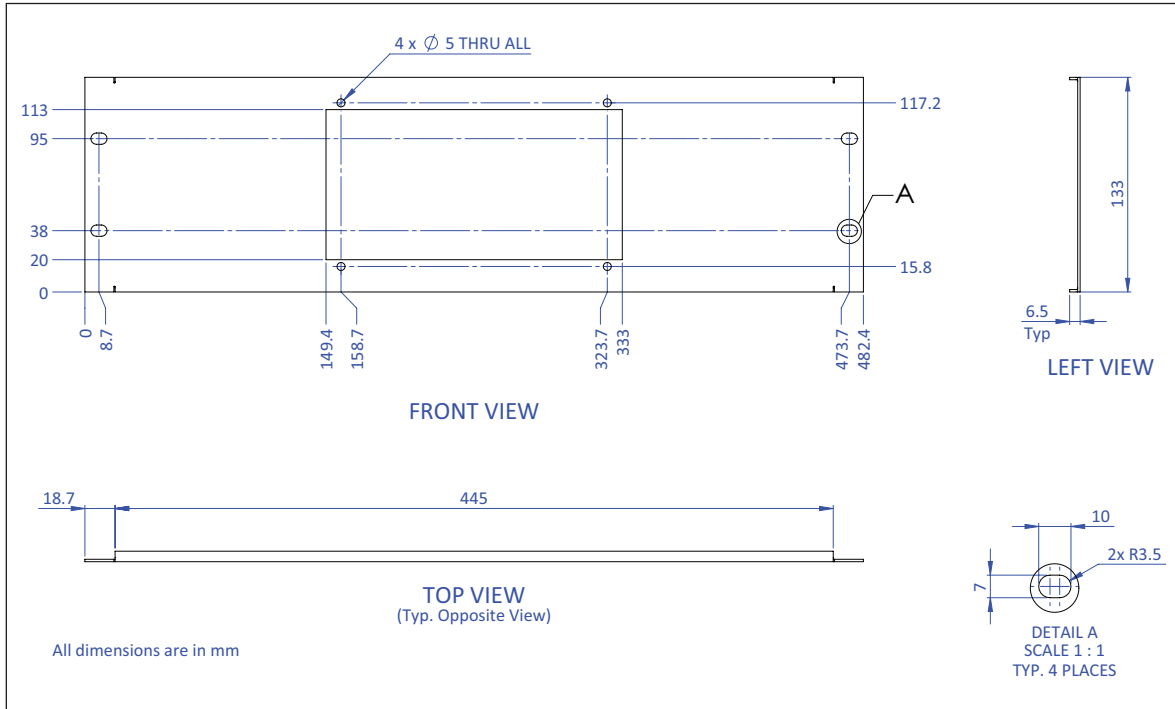

### 17.3 Inview XC - Dimensions

